

## Ultra-Fast Recovery Rectifier Diodes

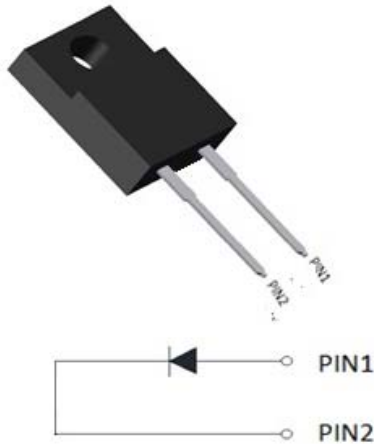

### Features

- High frequency operation
- High surge forward current capability
- High purity, high temperature epoxy encapsulation for enhanced mechanical strength and moisture resistance
- Adopt GPP chip
- Passivation for enhanced ruggedness and long term reliability
- Solder dip 275 °C max. 7 s, per JESD 22-B106

### Typical Applications

Typical applications are in switching power supplies, converters, freewheeling diodes, and reverse battery protection.

### Mechanical Data

- **Package:** ITO-220AC  
Molding compound meets UL 94 V-0 flammability rating, RoHS-compliant
- **Terminals:** Tin plated leads, solderable per J-STD-002 and JESD22-B102
- **Polarity:** As marked

### Limiting Values (Absolute Maximum Rating)

PARAMETER	SYMBOL	UNIT	SF860F-B1-0000S
Device Marking Code			SF860F
Repetitive Peak Reverse Voltage	VRRM	V	600
Average Rectified Output Current @60Hz half sine-wave, R-load, Tc(FIG.1)	Io	A	8
Surge(Non-repetitive)Forward Current @60Hz half-sine wave, 1 cycle, Ta=25°C	IFSM	A	100
Current Squared Time @1ms≤t<8.3ms Tj=25°C	I <sup>2</sup> t	A <sup>2</sup> s	41
Storage Temperature	Tstg	°C	-55 ~ +150
Junction Temperature	Tj	°C	-55 ~ +150

### Electrical Characteristics (Ta=25°C Unless otherwise specified)

PARAMETER	SYMBOL	UNIT	TEST CONDITIONS	SF860F-B1-0000S
Maximum instantaneous forward voltage drop per diode	VFM	V	IFM=8.0A	1.7
Maximum DC reverse current at rated DC blocking voltage per diode	I <sub>RRM1</sub>	uA	V <sub>RM</sub> =V <sub>VRRM</sub> Ta=25°C	10
	I <sub>RRM2</sub>		V <sub>RM</sub> =V <sub>VRRM</sub> Ta=125°C	500
Reverse Recovery Time	T <sub>rr</sub>	ns	I <sub>F</sub> =0.5A I <sub>RM</sub> =1A I <sub>RR</sub> =0.25A	35

### Thermal Characteristics (Ta=25°C Unless otherwise specified)

PARAMETER	SYMBOL	UNIT	SF860F-B1-0000S
Thermal Resistance Between junction and case	R <sub>θJ-C</sub>	°C/W	2.5



## Ordering Information (Example)

PREFERRED P/N	UNIT WEIGHT(g)	MINIMUM PACKAGE(pcs)	INNER BOX QUANTITY(pcs)	OUTER CARTON QUANTITY(pcs)	DELIVERY MODE
SF860F-B1-0000S	Approximate 1.37	50	1000	5000	Tube

## Characteristics (Typical)

FIG1: I<sub>o</sub> - T<sub>c</sub> Curve

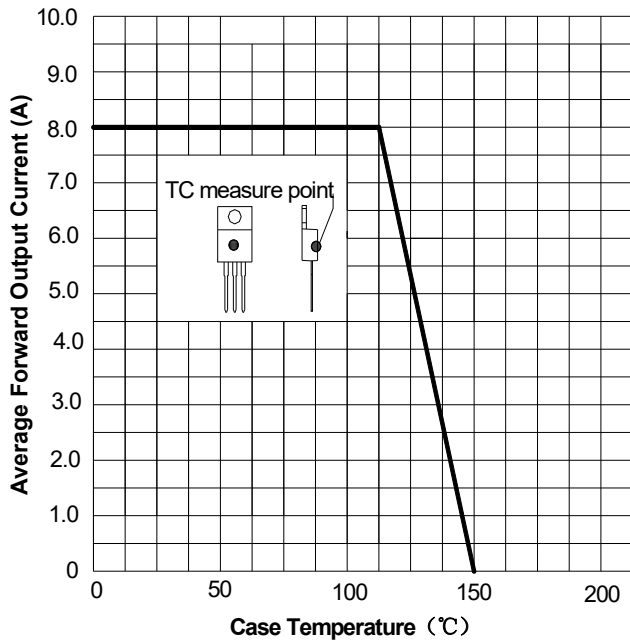

FIG2: Surge Forward Current Capability

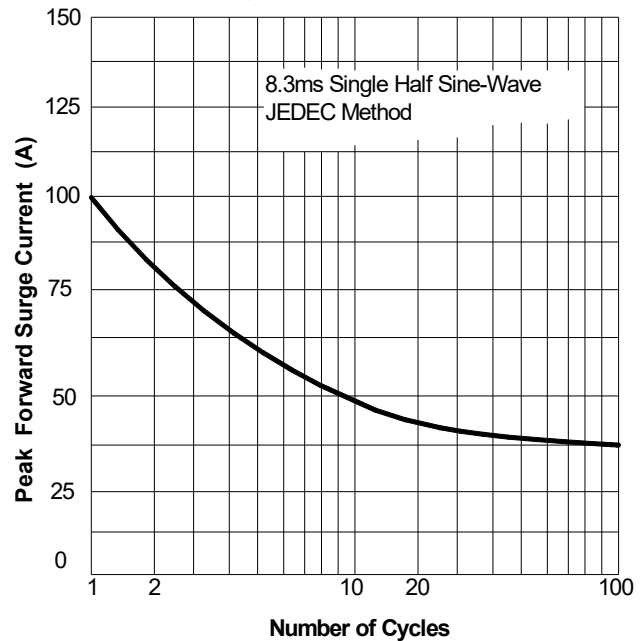

FIG3: Forward Voltage

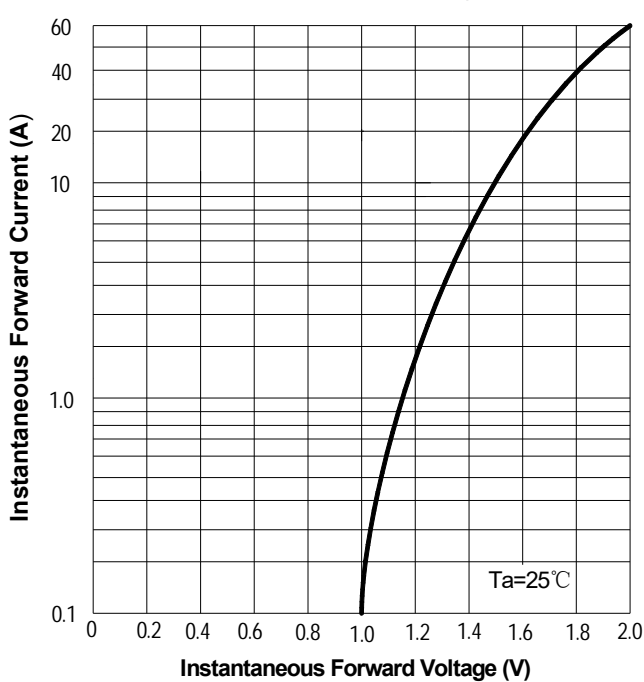

FIG4: Typical Reverse Characteristics

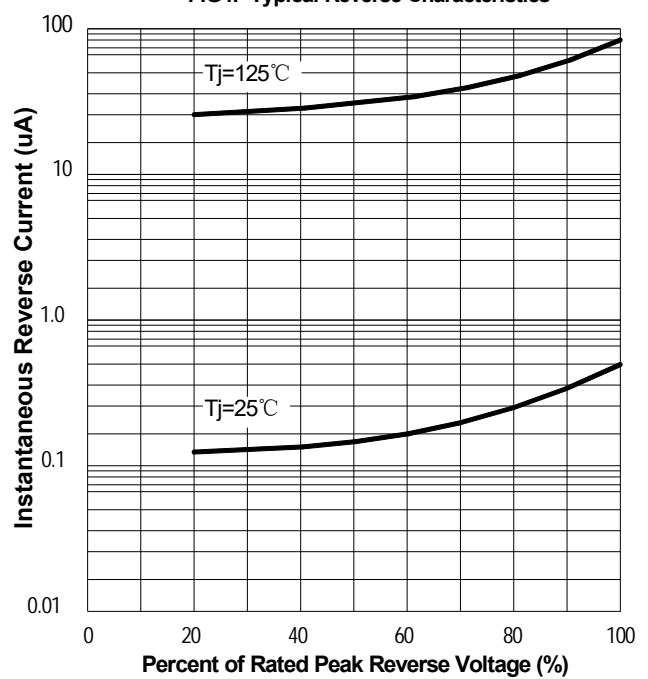
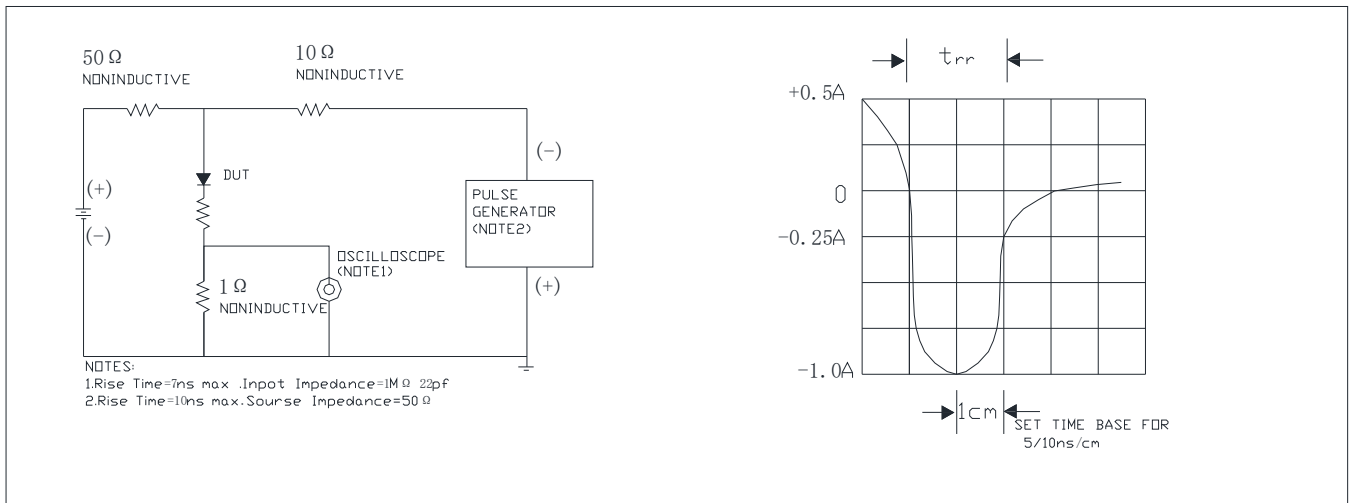
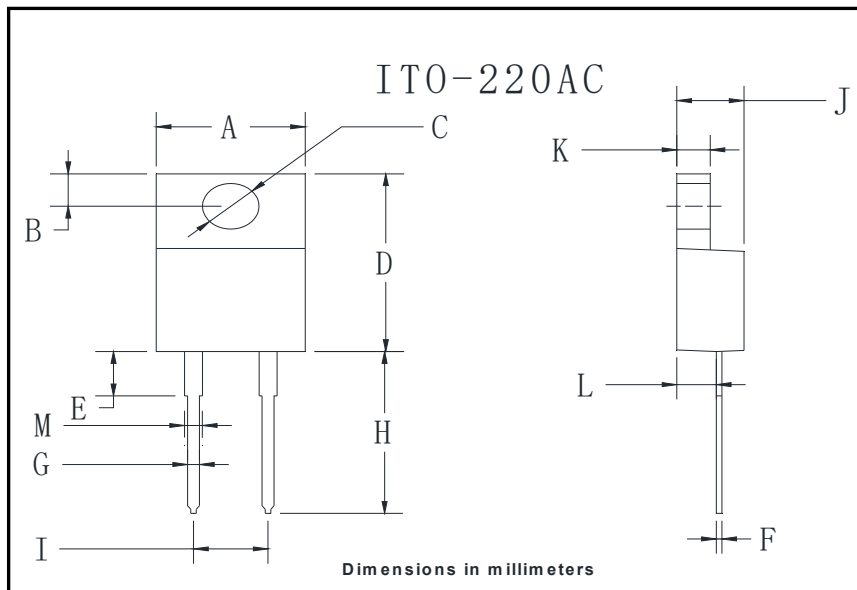

FIG.5 Diagram of circuit and Testing wave form of reverse recovery time



## ■ Outline Dimensions



ITO-220AC		
Dim	Min	Max
A	9.7	10.7
B	2.15	3.25
C	2.6	3.8
D	14.4	15.9
E	3.1	4.5
F	0.4	0.8
G	0.4	0.9
H	12.7	14.2
I	3.6	5.9
J	3.9	5.1
K	2.1	3.56
L	2.1	3.2
M	1.0	1.8



**Disclaimer**

The information presented in this document is for reference only. Yangzhou Yangjie Electronic Technology Co., Ltd. reserves the right to make changes without notice for the specification of the products displayed herein to improve reliability, function or design or otherwise.

The product listed herein is designed to be used with ordinary electronic equipment or devices, and not designed to be used with equipment or devices which require high level of reliability and the malfunction of which would directly endanger human life (such as medical instruments, transportation equipment, aerospace machinery, nuclear-reactor controllers, fuel controllers and other safety devices), Yangjie or anyone on its behalf, assumes no responsibility or liability for any damages resulting from such improper use of sale.

This publication supersedes & replaces all information previously supplied. For additional information, please visit our website <http://www.21yangjie.com> , or consult your nearest Yangjie's sales office for further assistance.