

Dual PNP Small Signal Transistor

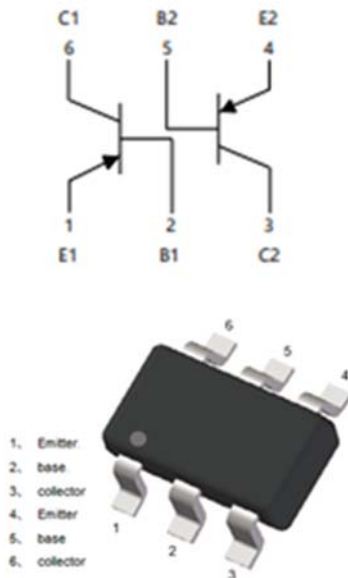

Features

- Moisture sensitivity level 1
- Halogen free and RoHS compliant
- Surface mount package ideally suited for automatic insertion

Application

- Signal amplification
- Switching circuit

Mechanical data

- **Package:** SOT-363S
- **Terminals:** Tin plated leads, solderable per J-STD-002 and JESD22-B102CC

■ Maximum Ratings ($T_a=25^\circ\text{C}$ Unless otherwise specified)

Item	Symbol	Unit	Conditions	Value
Device marking code				K2T
Collector-base voltage	V_{CB0}	V	$I_C = -100\mu\text{A}, I_E = 0$	-40
Collector-emitter voltage	V_{CE0}	V	$I_C = -1\text{mA}, I_B = 0$	-40
Emitter-base voltage	V_{EB0}	V	$I_E = -100\mu\text{A}, I_C = 0$	-5
Collector current	I_C	mA		-600
Power dissipation	P_D	mW		200
Operation junction temperature	T_J	$^\circ\text{C}$		-55 to +150
Storage temperature	T_{STG}	$^\circ\text{C}$		-55 to +150



MMDT4403S

RoHS
COMPLIANT

■ Electrical Characteristics (T_a=25°C Unless otherwise specified)

Item	Symbol	Unit	Conditions	Min	Typ	Max
Collector-base breakdown voltage	V _{(BR)CBO}	V	I _C =-100μA, I _E =0	-40		
Collector-emitter breakdown voltage	V _{(BR)CEO}	V	I _C =-1mA, I _B =0	-40		
Emitter-base breakdown voltage	V _{(BR)EBO}	V	I _E =-100μA, I _C =0	-5		
Collector-base cut-off current	I _{CBO}	nA	V _{CB} =-50V, I _E =0			-100
Collector cut-off current	I _{CEO}	nA	V _{CE} =-35V, I _B =0			-500
Emitter-base cut-off current	I _{EBO}	nA	V _{EB} =-5V, I _C =0			-100
DC current gain	h _{FE1}		V _{CE} =-1V, I _C =-0.1mA	30		
	h _{FE2}		V _{CE} =-1V, I _C =-1mA	60		
	h _{FE3}		V _{CE} =-1V, I _C =-10mA	100		
	h _{FE4}		V _{CE} =-1V, I _C =-150mA	100		300
	h _{FE5}		V _{CE} =-1V, I _C =-500mA	20		
Collector-emitter saturation voltage	V _{CE(sat)1}	V	I _C =-150mA, I _B =-15mA			-0.4
	V _{CE(sat)2}	V	I _C =-500mA, I _B =-50mA			-0.75
Base-emitter saturation voltage	V _{BE(sat)1}	V	I _C =-150mA, I _B =-15mA			-0.95
	V _{BE(sat)2}	V	I _C =-500mA, I _B =-50mA			-1.3
Transition frequency	f _T	MHz	V _{CE} =-10V, I _C =-20mA, f=100MHz	200		
Delay time	t _d	ns	V _{CC} =-30V, I _C =-150mA, V _{BE} =-2V, I _{B1} =-15mA			15
Rise time	t _r	ns				20
Storage time	t _s	ns	V _{CC} =-30V, I _C =-150mA, I _{B1} =-I _{B2} =-15mA			225
Fall time	t _f	ns				30

■ Thermal Characteristics

Parameter	Symbol	Unit	Value
Thermal resistance, junction-to-ambient	R _{θJ-A} ⁽¹⁾	°C/W	625
Thermal resistance, junction-to-case	R _{θJ-C} ⁽¹⁾	°C/W	500

Note:

(1) Device mounted on PCB, single-sided copper, with standard footprint



■ Characteristics

Fig 1: Static Characteristics

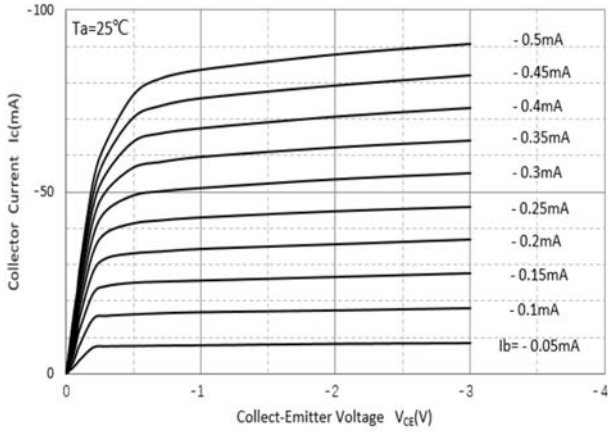

Fig 2: Dc Current Gain

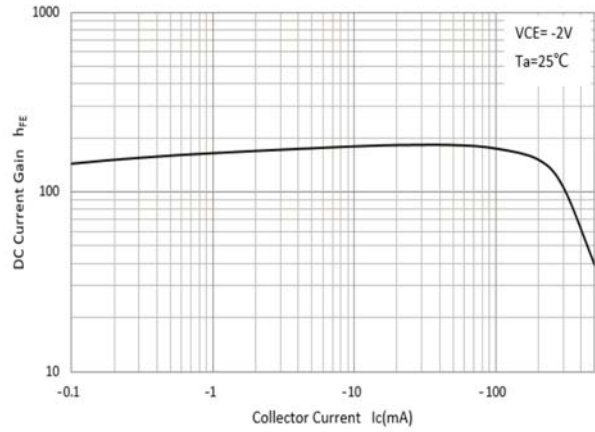

Fig 3: Collector-Emittor Saturation Voltage

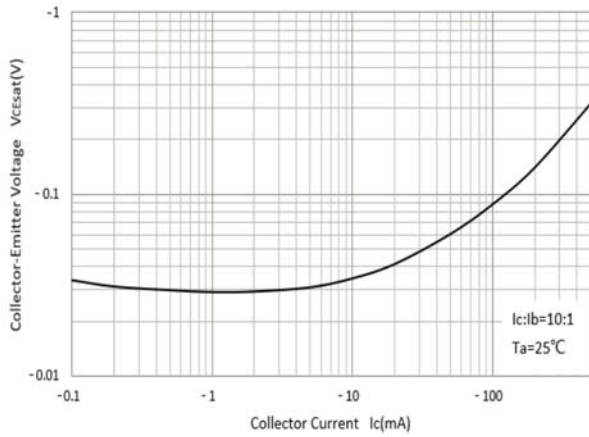

Fig 4: Base-Emittor Saturation Voltage

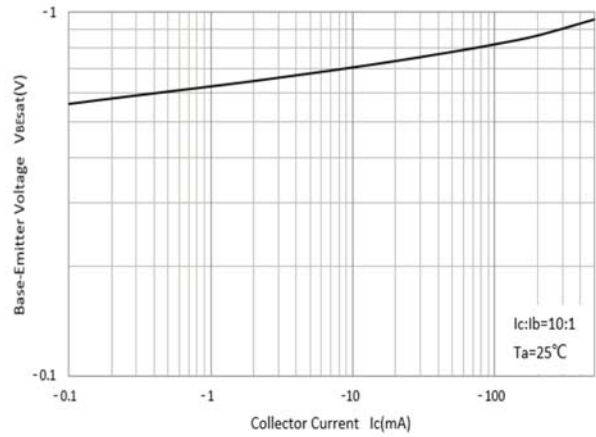

Fig 5: Base-Emittor Voltage

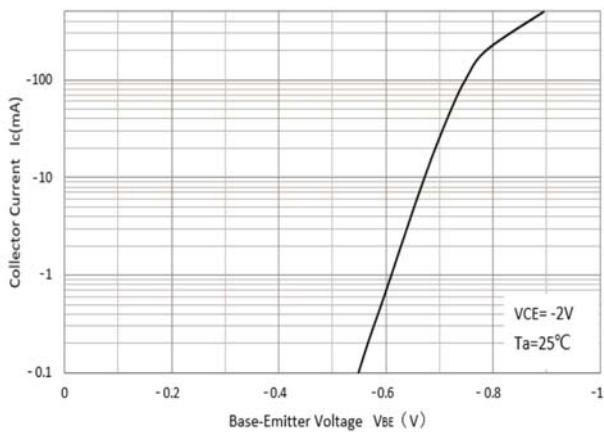

Fig 6: Cob/Cib-Vcb/Veb

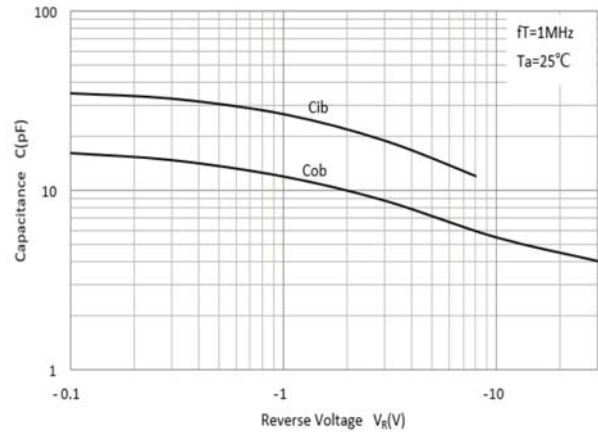
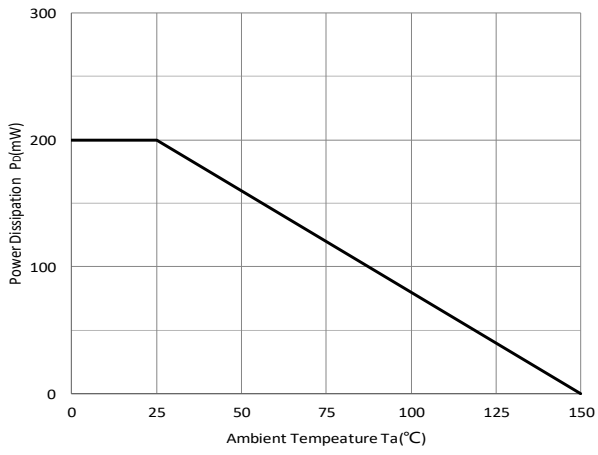



Fig 7: P_D-T_a Curve





MMDT4403S

RoHS
COMPLIANT

■ Ordering Information

Preferred P/N	Packing code	Unit weight(g)	Minimum package(pcs)	Inner box quantity(pcs)	Outer carton quantity(pcs)	Delivery mode
MMDT4403S	F2	Approximate 0.009	3000	30000	120000	7" reel
MMDT4403S	F3	Approximate 0.009	10000	/	210000	7" reel

■ Outline Dimensions

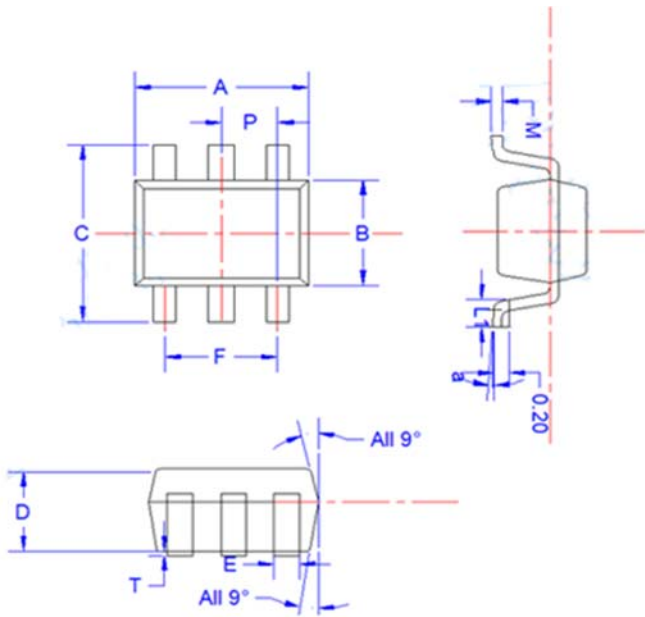

SYMBOL	MILLIMETER		
	MIN	NOM	MAX
E	0.15	0.25	0.35
B	1.15	1.25	1.35
C	2.00	2.10	2.20
P	0.650BSC		
A	1.80	2.00	2.20
T	0.00	0.05	0.100
D	0.90	0.95	1.00
L1	0.20	0.30	0.40
a	4°±4°		
M	0.10	0.15	0.25

■ Suggested Pad Layout

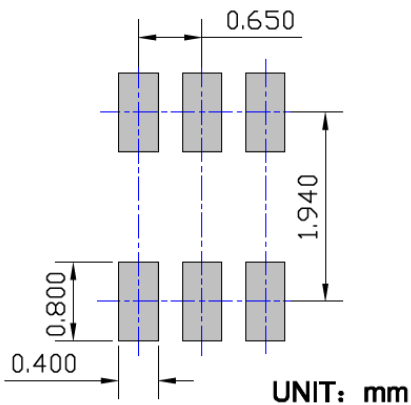



Disclaimer

The information presented in this document is for reference only. Yangzhou Yangjie Electronic Technology Co., Ltd. reserves the right to make changes without notice for the specification of the products displayed herein to improve reliability, function, or design or otherwise.

The product listed herein is designed to be used with ordinary electronic equipment or devices, and not designed to be used with equipment or devices which require high level of reliability and the malfunction of which would directly endanger human life (such as medical instruments, transportation equipment, aerospace machinery, nuclear-reactor controllers, fuel controllers and other safety devices), Yangjie or anyone on its behalf, assumes no responsibility or liability for any damages resulting from such improper use of sale.

This publication supersedes & replaces all information previously supplied. For additional information, please visit our website [http:// www.21yangjie.com](http://www.21yangjie.com) , or consult your nearest Yangjie's sales office for further assistance.