

## Small Signal Schottky Diode



### Features

- Epoxy meets UL-94 V-0 flammability rating and halogen free
- Moisture Sensitivity Level 1
- Low Forward Voltage Schottky Rectifier
- $V_{RRM}$  70V
- $I_{FAV}$  70mA
- Part no. with suffix "Q" means AEC-Q101 qualified

### Applications

- For Transient and ESD Protection
- Automotive

### SOT-23

### Mechanical Data

- **Case:** SOT-23
- **Terminals:** Tin plated leads, solderable per J-STD-002 and JESD22-B102

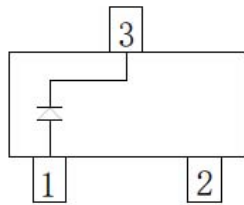

BAS70Q  
Marking:73

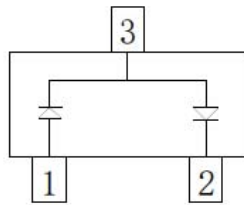

BAS70-04Q  
Marking:74

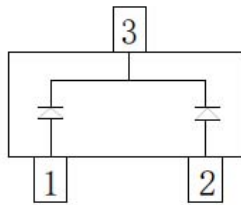

BAS70-05Q  
Marking:75

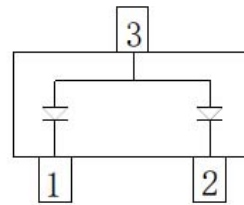

BAS70-06Q  
Marking:76

### ■ Maximum Ratings ( $T_a=25^{\circ}\text{C}$ Unless otherwise specified)

PARAMETER	SYMBOL	UNIT	CONDITIONS	VALUE
Repetitive Peak Reverse Voltage	$V_{RRM}$	V		70
Average Forward Current	$I_{FAV}$	mA		70
Peak Forward Surge Current	$I_{FSM}$	A	$t=8.3\text{ms}$	3
Power Dissipation	$P_{tot}$	mW		250
Thermal Resistance Junction to Ambient	$R_{thJA}$	K/W		500
Junction Temperature	$T_j$	$^{\circ}\text{C}$		-55 to +150
Storage Temperature Range	$T_{stg}$	$^{\circ}\text{C}$		-55 to +150



# BAS70Q&BAS70-04Q&BAS70-05Q&BAS70-06Q

## ■ Electrical Characteristics (T<sub>a</sub>=25°C Unless otherwise specified)

PARAMETER	SYMBOL	UNIT	CONDITIONS	MIN	MAX
Forward Voltage	V <sub>F</sub>	V	I <sub>F</sub> =1mA		0.41
			I <sub>F</sub> =15mA		1
Reverse Current	I <sub>R</sub>	μA	V <sub>R</sub> =50V		0.2
Breakdown Voltage	V <sub>BR</sub>	V	I <sub>R</sub> =10μA	70	
Junction Capacitance	C <sub>J</sub>	pF	V <sub>R</sub> =0 V, f =1MHZ		4
Reverse Recovery Time	t <sub>rr</sub>	ns	I <sub>F</sub> =I <sub>R</sub> =10mA, I <sub>rr</sub> =1mA, R <sub>L</sub> =100Ω		5

## ■ Ordering Information (Example)

PREFERRED P/N	PACKING CODE	UNIT WEIGHT(g)	MINIMUM PACKAGE(pcs)	INNER BOX QUANTITY(pcs)	OUTER CARTON QUANTITY(pcs)	DELIVERY MODE
BAS70Q/ BAS70-04Q/ BAS70-05Q/ BAS70-06Q	F2	Approximate 0.01	3000	30000	120000	7" reel



## ■ Characteristics (Typical)

Fig.1:  $P_D-T_A$

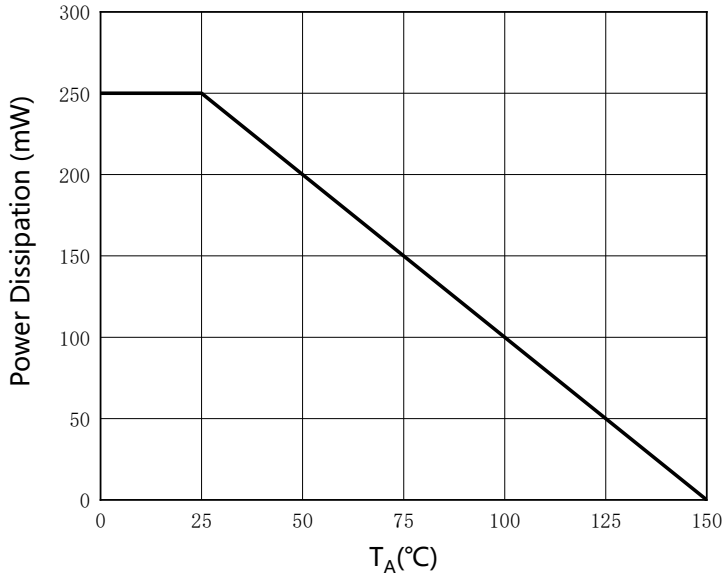

Fig.2: Capacitance Characteristics

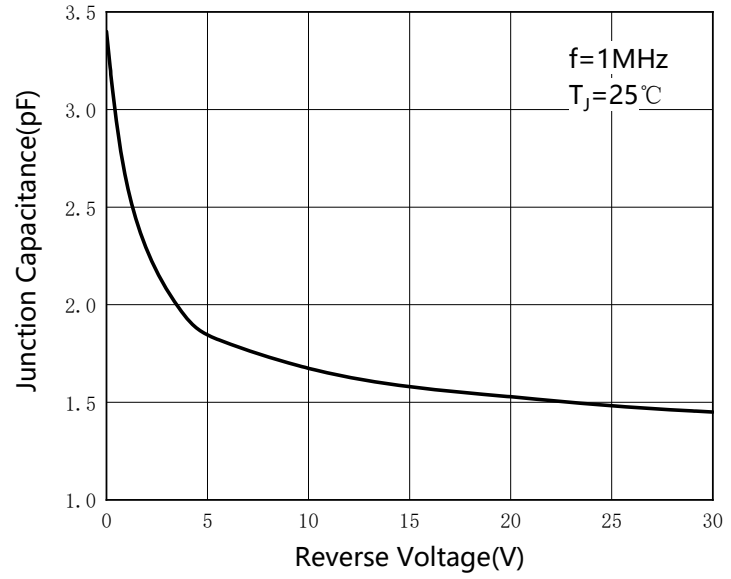

Fig.3: Forward Characteristics

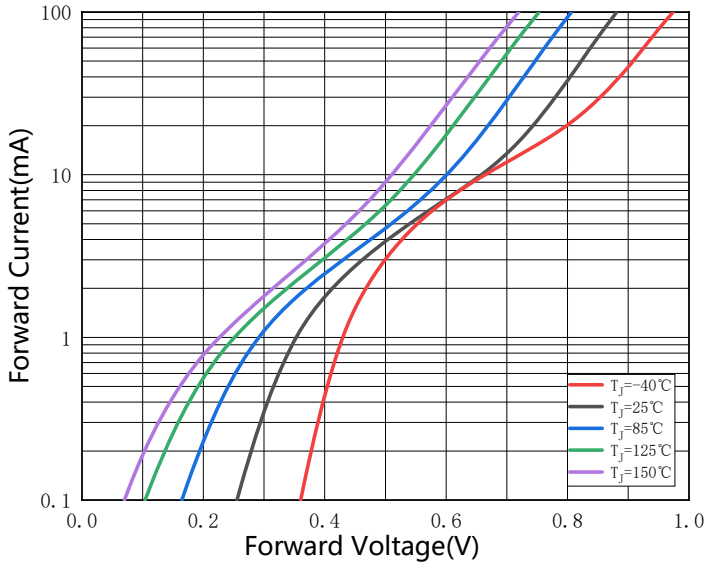
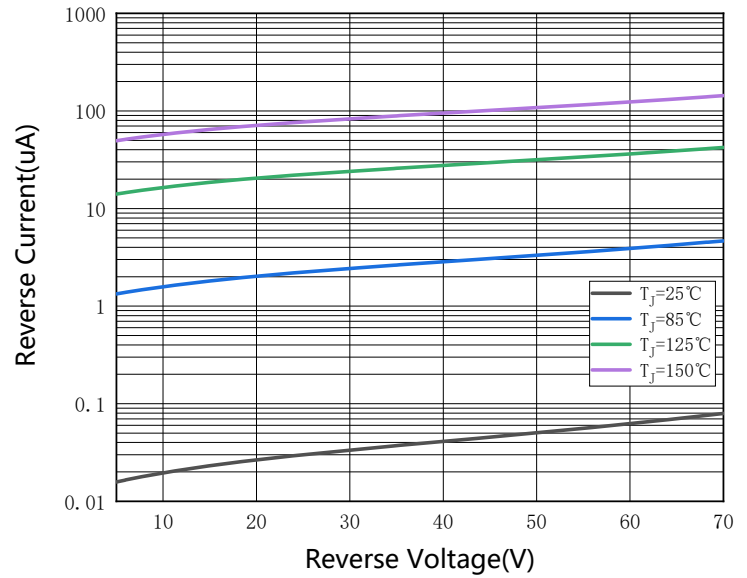
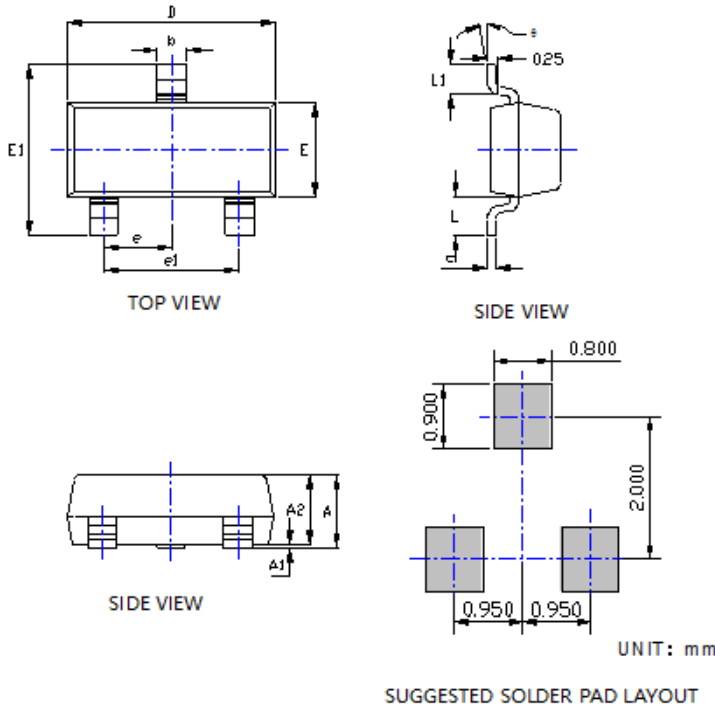

Fig.4: Reverse Characteristics





■ **Outline Dimensions**



SYMBOL	DIMENSIONS			
	INCHES		Millimeter	
	MIN.	MAX.	MIN.	MAX.
A	0.035	0.045	0.900	1.150
A1	0.000	0.004	0.000	0.100
A2	0.035	0.041	0.900	1.050
b	0.012	0.020	0.300	0.500
c	0.004	0.008	0.100	0.200
D	0.110	0.118	2.800	3.000
E	0.047	0.055	1.200	1.400
E1	0.089	0.100	2.250	2.550
e	0.037TYP		0.950TYP	
e1	0.071	0.079	1.800	2.000
L	0.022REF		0.550REF	
L1	0.012	0.020	0.300	0.500
θ	0°	8°	0°	8°

NOTE:  
 1. PACKAGE BODY SIZES EXCLUDE MOLD FLASH AND GATE BURRS.  
 2. TOLERANCE 0.1mm UNLESS OTHERWISE SPECIFIED.  
 3. THE PAD LAYOUT IS FOR REFERENCE PURPOSES ONLY.

■ **Marking Information**

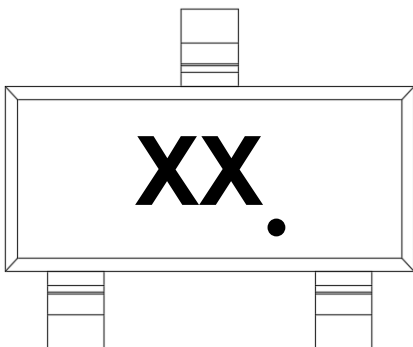

PN	Marking Code
BAS70Q	73.
BAS70- 04Q	74.
BAS70-05Q	75.
BAS70- 06Q	76.

- Note:
1. All marking is at middle of the product body
  2. All marking is in laser marking
  3. XX. is Marking Code
  4. Body color: Black



## Disclaimer

The information presented in this document is for reference only. Yangzhou Yangjie Electronic Technology Co., Ltd. reserves the right to make changes without notice for the specification of the products displayed herein to improve reliability, function or design or otherwise.

The product listed herein is designed to be used with automotive electronics, are not designed for use in medical, life-saving, life-sustaining, or military, Yangjie or anyone on its behalf, assumes no responsibility or liability for any damages resulting from such improper use of sale.

This publication supersedes & replaces all information previously supplied. For additional information, please visit our website [http:// www.21yangjie.com](http://www.21yangjie.com) , or consult your nearest Yangjie's sales office for further assistance.