

Surface Mount Schottky Rectifier

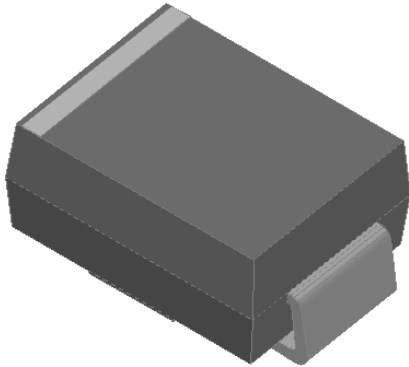

Features

- Low profile package
- Ideal for automated placement
- Guardring for overvoltage protection
- Low power losses, high efficiency
- High forward surge capability
- Meets MSL level 1, per J-STD-020, LF maximum peak of 260 °C
- Part no. with suffix "Q" means AEC-Q101 qualified

Typical Applications

For use in low voltage high frequency inverters, freewheeling, DC/DC converters, automotive and polarity protection applications.

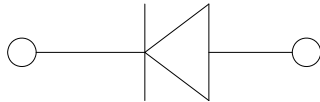

Mechanical Data

- **Package:** DO-214AA (SMB)
Molding compound meets UL 94 V-0 flammability rating, RoHS-compliant, halogen-free
- **Terminals:** Tin plated leads, solderable per J-STD-002 and JESD22-B102
- **Polarity:** Cathode line denotes the cathode end

■ Maximum Ratings (T_a=25°C Unless otherwise specified)

PARAMETER	SYMBOL	UNIT	SS26Q
Device marking code			SS26
Repetitive peak reverse voltage	V _{RRM}	V	60
Maximum RMS voltage	V _{RMS}	V	42
Maximum DC blocking voltage	V _{DC}	V	60
Maximum average forward rectified current at T _L (Fig.1)	I _O	A	2.0
Surge(non-repetitive)forward current @60Hz half-sine wave,1 cycle, T _J =25°C	I _{FSM}	A	75
Voltage rate of change (rated V _R)	dV/dt	V/μs	10000
Storage temperature	T _{stg}	°C	-55 ~+150
Junction temperature	T _J	°C	-55 ~+150

■ Electrical Characteristics(T_a=25°C Unless otherwise specified)

PARAMETER	SYMBOL	TEST CONDITIONS	TYP	MAX	UNIT	
Instantaneous forward voltage	V _F	I _F =2A	T _J =25°C	0.58	0.7	V
			T _J =125°C	0.53	0.63	
Reverse current	I _R	Rated V _R	T _J =25°C	8	100	μA
			T _J =125°C	-	10	mA
Typical junction capacitance	C _J	V _R =4V,f=1MHz	95	-	pF	



SS26Q

■ Thermal Characteristics (T_a=25°C Unless otherwise specified)

PARAMETER	SYMBOL	UNIT	SS26Q
Thermal Resistance	R _{θJ-A}	°C/W	75 ¹⁾
	R _{θJ-L}		17 ¹⁾

Note:
 (1) Thermal resistance from junction to ambient and from junction to lead mounted on P.C.B. with 0.2" x 0.2" (5.0 mm x 5.0 mm) copper pad areas

■ Characteristics(Typical)

Fig.1:Forward Current Derating Curve

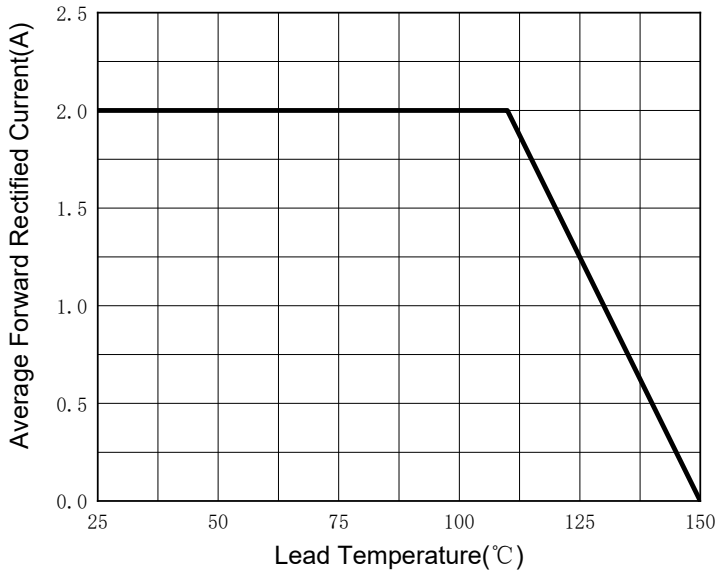

Fig.2:Maximum Non-Repetitive Peak Forward Surge Current

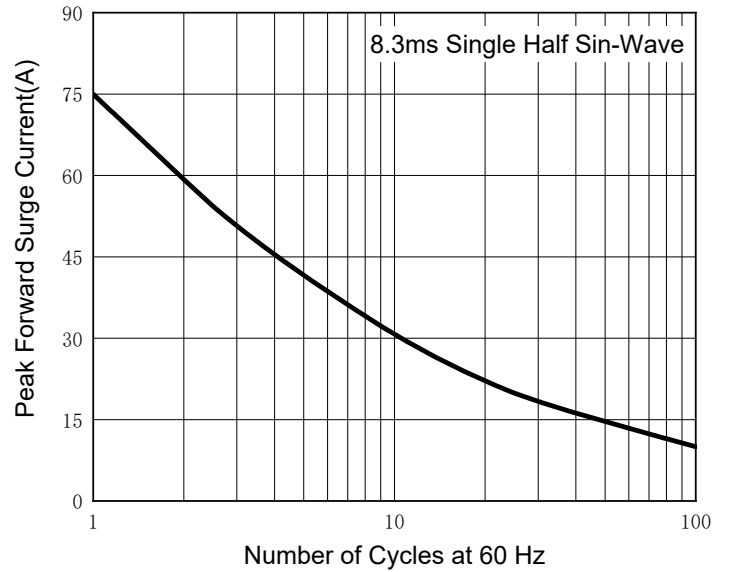

Fig.3:Typical Instantaneous Forward Characteristics

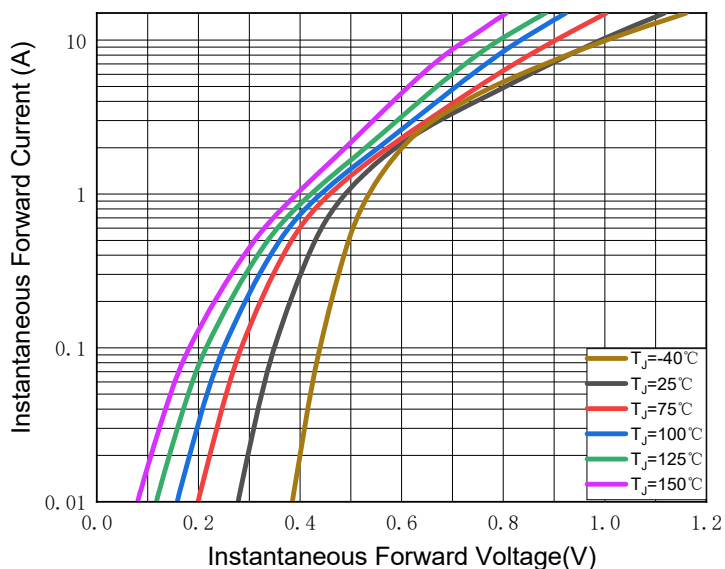
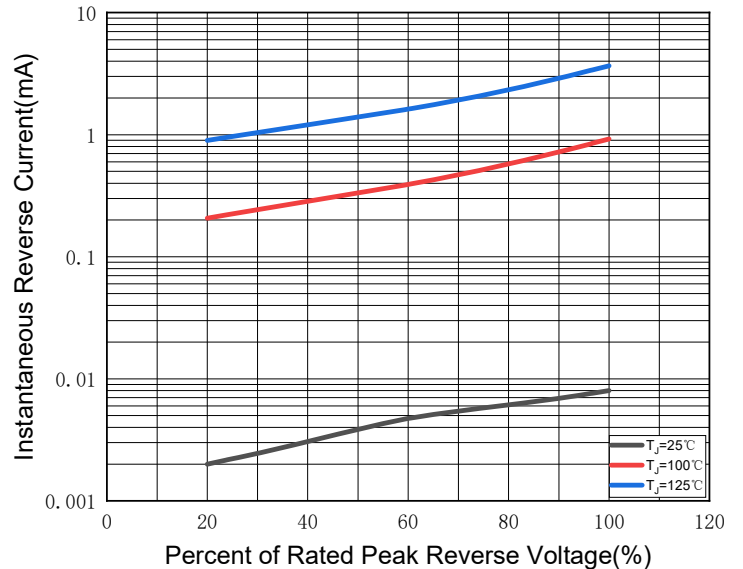

Fig.4:Typical Reverse Leakage Characteristics



■ Ordering Information (Example)

PREFERRED P/N	PACKING CODE	UNIT WEIGHT(g)	MINIMUM PACKAGE(pcs)	OUTER CARTON QUANTITY(pcs)	DELIVERY MODE
SS26Q	F1	Approximate 0.1003	3000	48000	13" reel

■ Outline Dimensions

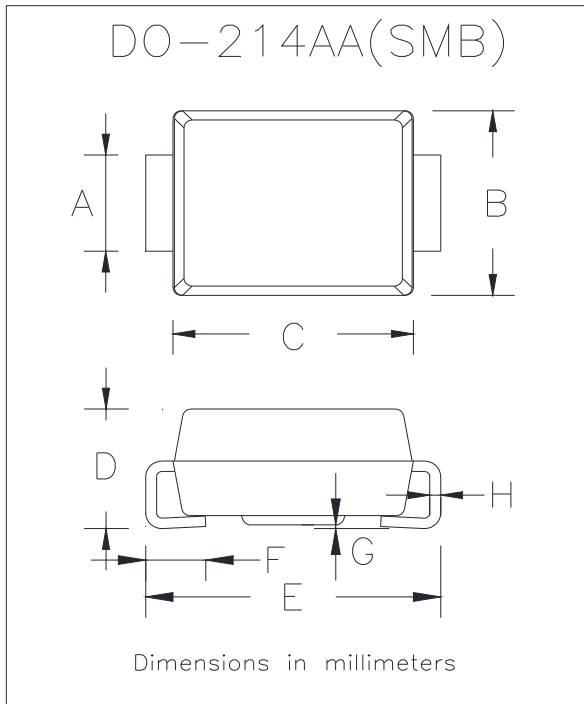

DO-214AA(SMB)		
Dim	Min	Max
A	1.85	2.15
B	3.30	3.94
C	4.05	4.75
D	1.99	2.61
E	5.21	5.59
F	0.90	1.41
G	0.05	0.20
H	0.15	0.31

■ Suggested pad layout

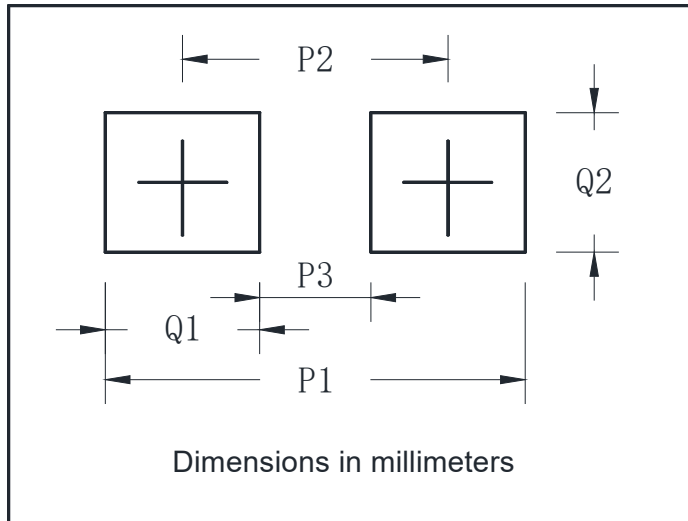

DO-214AA(SMB)	
Dim	Millimeters
P1	6.8
P2	4.3
P3	1.8
Q1	2.5
Q2	2.3



SS26Q

Disclaimer

The information presented in this document is for reference only. Yangzhou Yangjie Electronic Technology Co., Ltd. reserves the right to make changes without notice for the specification of the products displayed herein to improve reliability, function or design or otherwise.

The product listed herein is designed to be used with automotive electronics, are not designed for use in medical, lifesaving, lifesustaining, or military, Yangjie or anyone on its behalf, assumes no responsibility or liability for any damages resulting from such improper use of sale.

This publication supersedes & replaces all information previously supplied. For additional information, please visit our website [http:// www.21yangjie.com](http://www.21yangjie.com) , or consult your nearest Yangjie's sales office for further assistance.