

P-Channel Enhancement Mode Field Effect Transistor

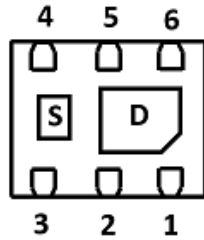

DFN2x2-6L

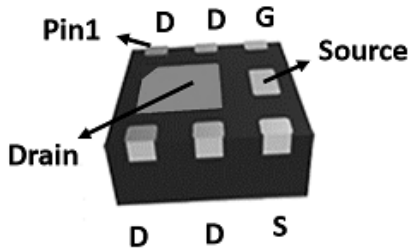
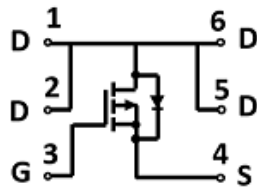

Product Summary

• V_{DS}	-20V
• I_D	-7A
• $R_{DS(ON)}$ (at $V_{GS}=-4.5V$)	<36.5mohm
• $R_{DS(ON)}$ (at $V_{GS}=-2.5V$)	<46.5mohm
• $R_{DS(ON)}$ (at $V_{GS}=-1.8V$)	<60.5mohm

General Description

- Trench Power LV MOSFET technology
- High density cell design for Low $R_{DS(ON)}$
- High Speed switching

Applications

- Battery protection
- Power management
- Load switch

■ Absolute Maximum Ratings ($T_A=25^\circ C$ unless otherwise noted)

Parameter	Symbol	Maximum	Unit
Drain-source Voltage	V_{DS}	-20	V
Gate-source Voltage	V_{GS}	± 10	V
Drain Current	I_D	$T_C=25^\circ C$ @ Steady State	-7
		$T_C=70^\circ C$ @ Steady State	-5.6
Pulsed Drain Current ^A	I_{DM}	-28	A
Total Power Dissipation @ $T_C=25^\circ C$ ^C	P_D	2.2	W
Thermal Resistance Junction-to-Ambient @ Steady State ^D	$R_{\theta JA}$	57	$^\circ C/W$
Junction and Storage Temperature Range	T_J, T_{STG}	-55~+150	$^\circ C$

■ Ordering Information (Example)

PREFERRED P/N	PACKING CODE	Marking	MINIMUM PACKAGE(pcs)	INNER BOX QUANTITY(pcs)	OUTER CARTON QUANTITY(pcs)	DELIVERY MODE
YJQ4666B	F1	..G66B	3000	30000	120000	7 " reel



YJQ4666B

■ Electrical Characteristics (T_J=25°C unless otherwise noted)

Parameter	Symbol	Conditions	Min	Typ	Max	Units
Static Parameter						
Drain-Source Breakdown Voltage	BV _{DSS}	V _{GS} = 0V, I _D =-250μA	-20			V
Zero Gate Voltage Drain Current	I _{DSS}	V _{DS} =-20V, V _{GS} =0V			-1	μA
Gate-Body Leakage Current	I _{GSS}	V _{GS} = ±10V, V _{DS} =0V			±100	nA
Gate Threshold Voltage	V _{GS(th)}	V _{DS} = V _{GS} , I _D =-250μA	-0.4	-0.62	-1.0	V
Static Drain-Source On-Resistance	R _{DS(ON)}	V _{GS} = -4.5V, I _D =-7A		24.5	36.5	mΩ
		V _{GS} = -2.5V, I _D =-5A		33.5	46.5	
		V _{GS} = -1.8V, I _D =-2A		45.5	60.5	
Diode Forward Voltage	V _{SD}	I _S =-7A, V _{GS} =0V		-0.7	-1.2	V
Dynamic Parameters						
Input Capacitance	C _{iss}	V _{DS} =-10V, V _{GS} =0V, f=1MHZ		852		pF
Output Capacitance	C _{oss}			127		
Reverse Transfer Capacitance	C _{rss}			109		
Switching Parameters						
Total Gate Charge	Q _g	V _{GS} =-4.5V, V _{DS} =-9V, I _D =-7A		40.1		nC
Gate Source Charge	Q _{gs}			8.4		
Gate Drain Charge	Q _{gd}			8.6		
Reverse Recovery Charge	Q _{rr}	I _F = -15A, di/dt=100A/us		7.8		
Reverse Recovery Time	t _{rr}			18		
Turn-on Delay Time	t _{D(on)}	V _{GS} =-4.5V, V _{DD} =-9V, I _D =-1A, R _{GEN} =2.5Ω		8		ns
Turn-on Rise Time	t _r			19		
Turn-off Delay Time	t _{D(off)}			75		
Turn-off Fall Time	t _f			46		

A. Pulse Test: Pulse Width ≤ 300us, Duty cycle ≤ 2%.

B. R_{θJA} is the sum of the junction-to-case and case-to-ambient thermal resistance, where the case thermal reference is defined as the solder mounting surface of the drain pins. R_{θJC} is guaranteed by design, while R_{θJA} is determined by the board design. The maximum rating presented here is based on mounting on a 1 in 2 pad of 2oz copper.



■ Typical Performance Characteristics

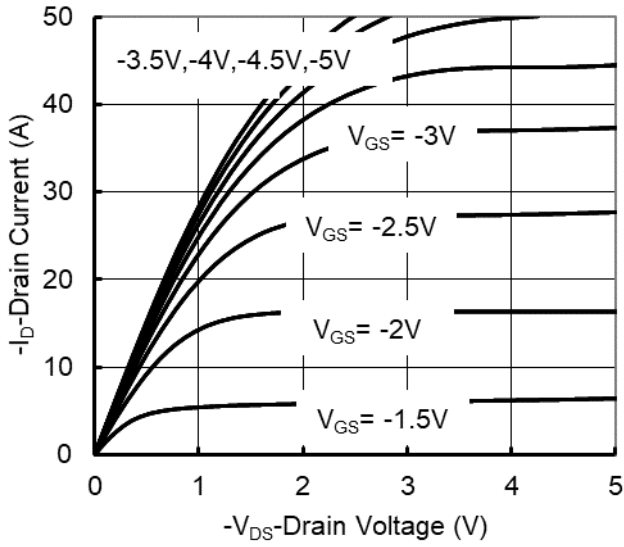

Figure 1. Output Characteristics

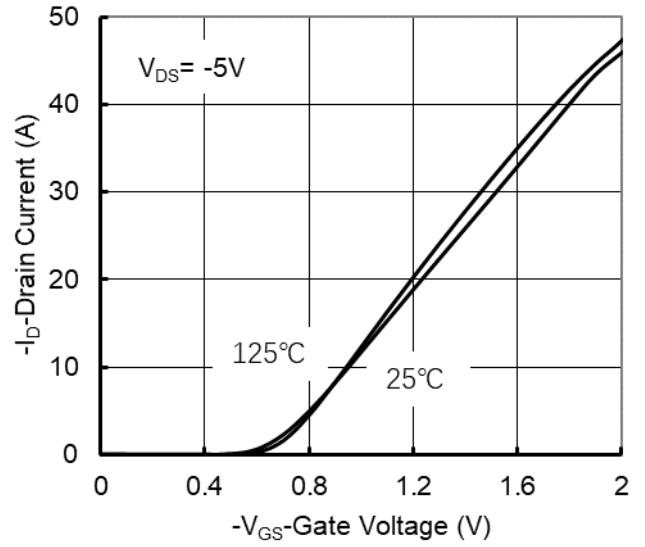

Figure 2. Transfer Characteristics

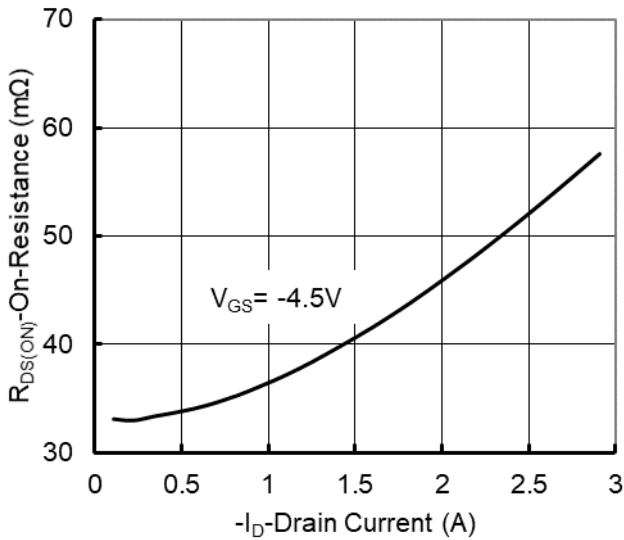

Figure 3. On-Resistance vs. Drain Current and Gate Voltage

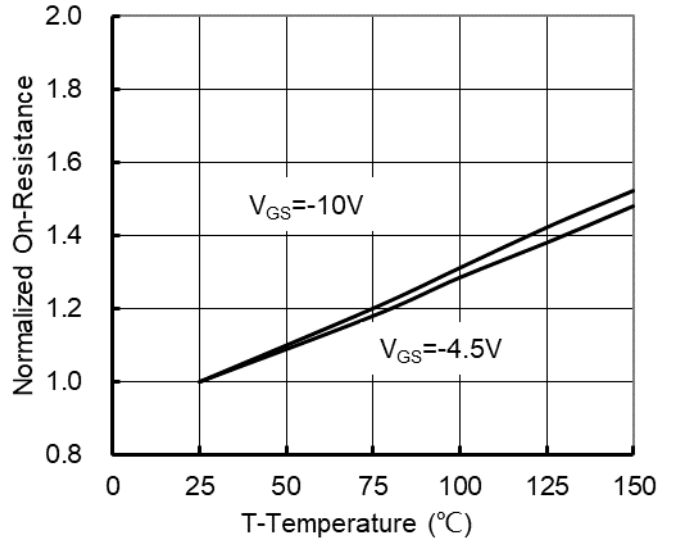

Figure 4. On-Resistance vs. Junction Temperature

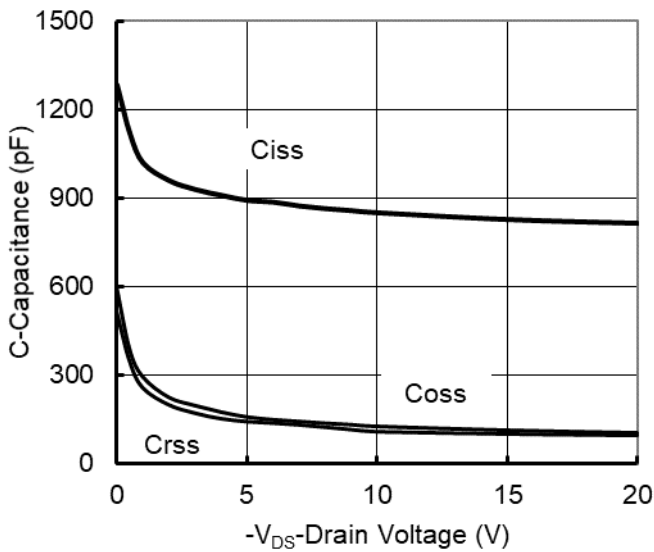

Figure 5. Capacitance Characteristics

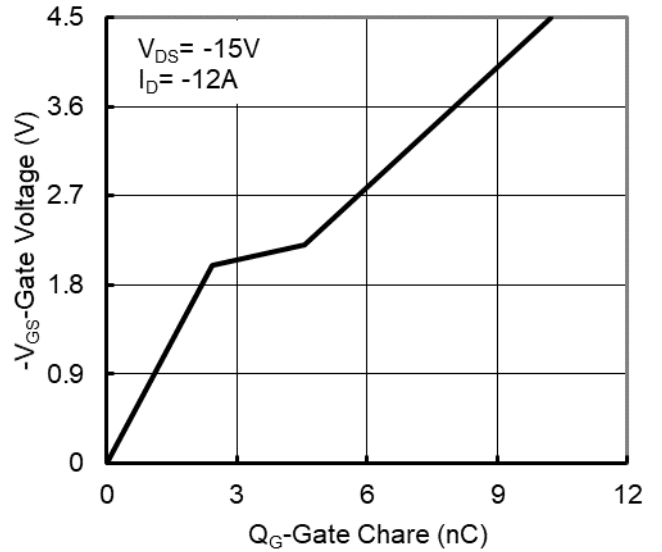

Figure 6. Gate Charge

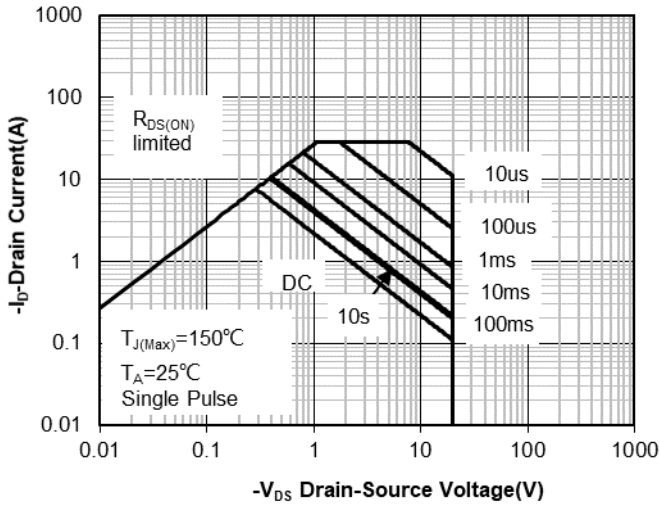

Figure 7. Safe Operation Area

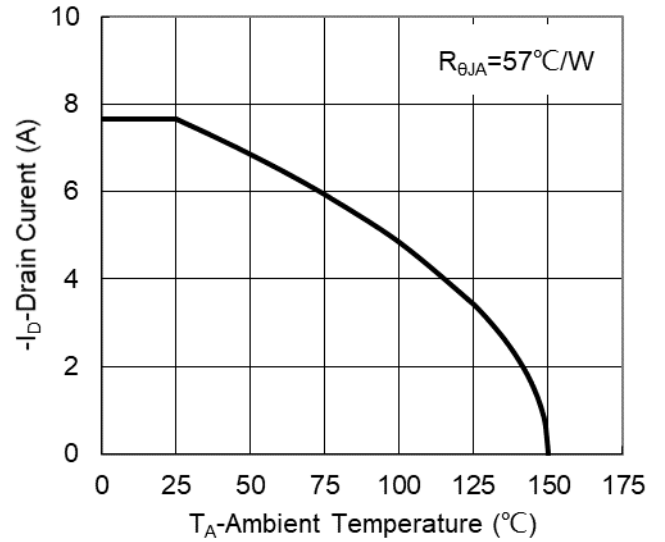

Figure 8. Maximum Continuous Drain Current vs Case Temperature

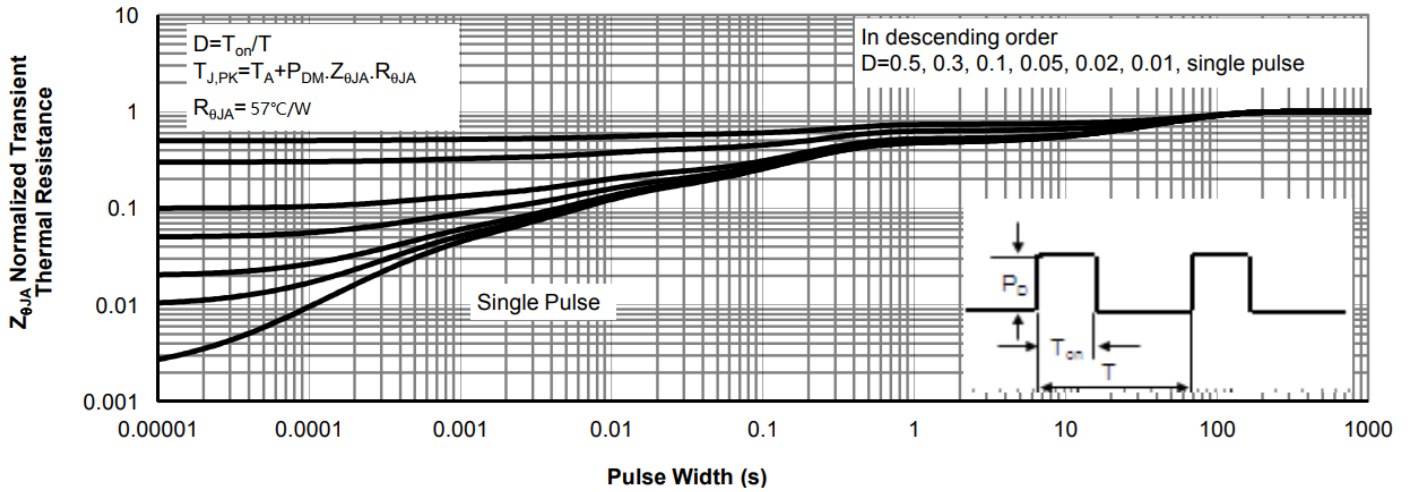
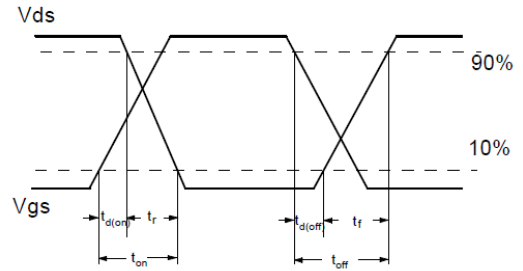
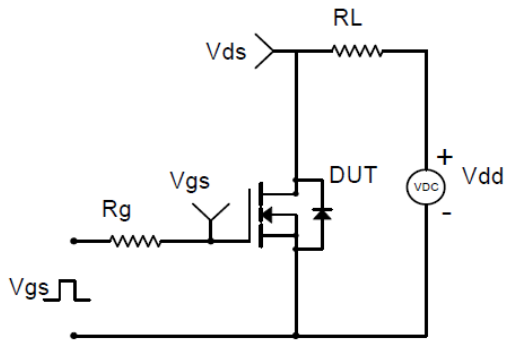
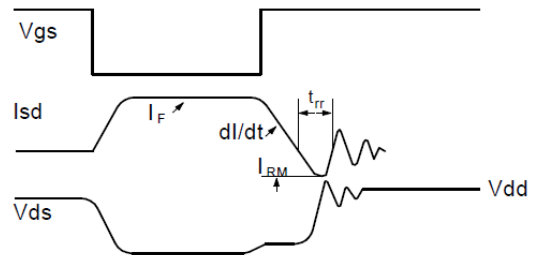
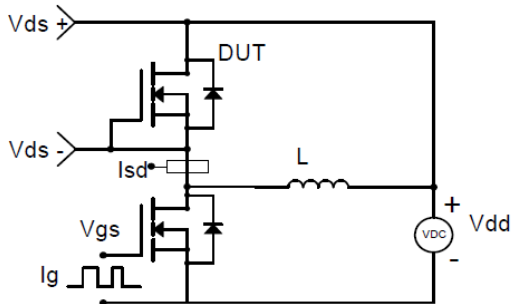

Figure 9. Normalized Maximum Transient Thermal Impedance



Resistive Switching Test Circuit & Waveforms



Diode Recovery Test Circuit & Waveforms

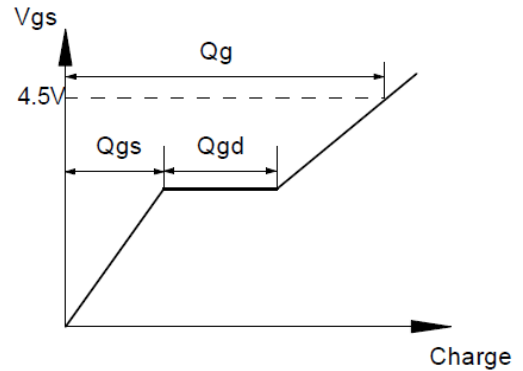
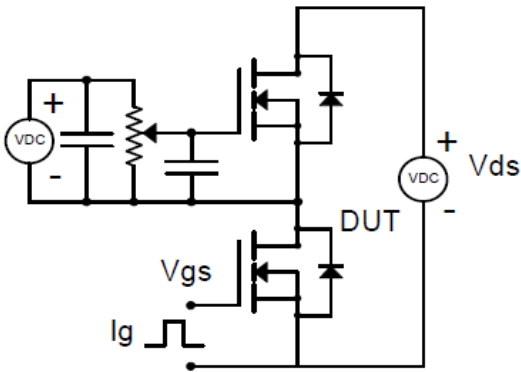

Gate Charge Test Circuit & Waveform

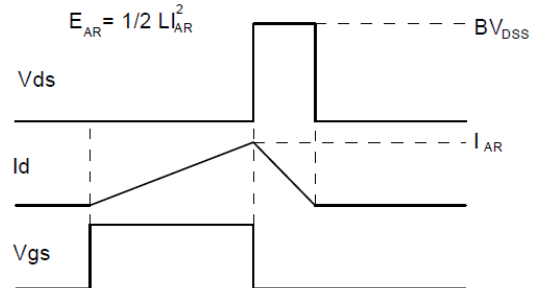
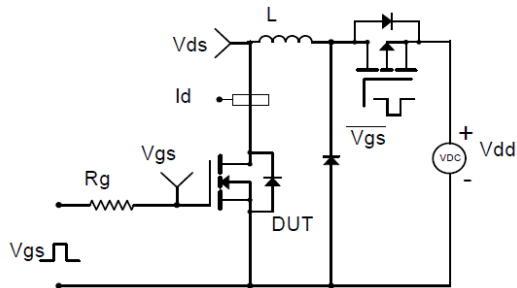

Unclamped Inductive Switching (UIS) Test Circuit & Waveforms



YJQ4666B

■ DFN2x2-6L(0.45mm) Package Information

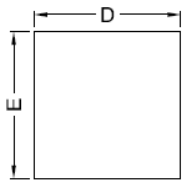

Top View
正面视图

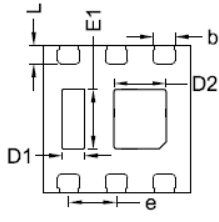

Bottom View
背面视图

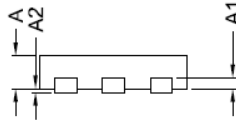

Side View
侧面视图

SYMBOL	MILLIMETER		
	MIN	NOM	MAX
D	1.90	2.00	2.10
E	1.90	2.00	2.10
A	0.35	0.45	0.55
A1	0.15 BSC		
A2			0.10
D1	0.20	0.30	0.40
D2	0.61	0.71	0.81
E1	0.71	0.81	0.91
L	0.15	0.25	0.35
b	0.20	0.30	0.40
e	0.65 BSC		

Note:

1. Controlling dimension: in millimeters.
2. General tolerance: ± 0.10 mm.
3. The pad layout is for reference purposes only.

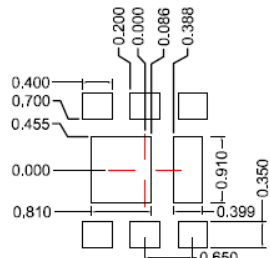

Suggested Solder Pad Layout
Top View



YJQ4666B

Disclaimer

The information presented in this document is for reference only. Yangzhou Yangjie Electronic Technology Co., Ltd. reserves the right to make changes without notice for the specification of the products displayed herein to improve reliability, function or design or otherwise.

The product listed herein is designed to be used with ordinary electronic equipment or devices, and not designed to be used with equipment or devices which require high level of reliability and the malfunction of which would directly endanger human life (such as medical instruments, transportation equipment, aerospace machinery, nuclear-reactor controllers, fuel controllers and other safety devices), Yangjie or anyone on its behalf, assumes no responsibility or liability for any damages resulting from such improper use of sale.

This publication supersedes & replaces all information previously supplied. For additional information, please visit our website [http:// www.21yangjie.com](http://www.21yangjie.com) , or consult your nearest Yangjie's sales office for further assistance.