

N-Channel Enhancement Mode Field Effect Transistor

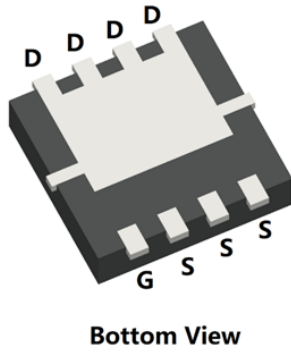

PDFN3333-8L

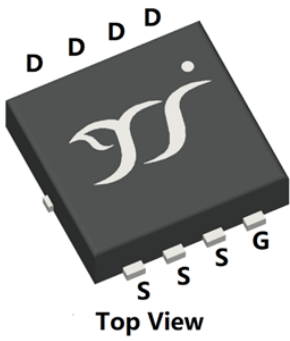
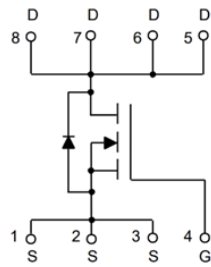

Product Summary

- V_{DS} 100V
- I_D 10A
- $R_{DS(ON)}$ (at $V_{GS}=10V$) $< 120m\Omega$
- $R_{DS(ON)}$ (at $V_{GS}=4.5V$) $< 130m\Omega$
- 100% EAS Tested
- 100% ∇V_{DS} Tested

General Description

- Trench Power MV MOSFET technology
- Excellent package for heat dissipation
- High density cell design for low $R_{DS(ON)}$
- Moisture Sensitivity Level 1
- Epoxy Meets UL 94 V-0 Flammability Rating
- Halogen Free

Applications

- Power management functions
- DC-DC convertor

■ Absolute Maximum Ratings ($T_J=25^\circ C$ unless otherwise noted)

Parameter			Symbol	Limit	Unit
Drain-source Voltage			V_{DS}	100	V
Gate-source Voltage			V_{GS}	± 20	V
Continuous Drain Current (Note 1,2)	Steady-State	$T_A=25^\circ C$	I_D	2.6	A
		$T_A=100^\circ C$		1.8	
Continuous Drain Current (Note 1,3)	Steady-State	$T_C=25^\circ C$		10	
		$T_C=100^\circ C$		7	
Pulsed Drain Current	$T_C=25^\circ C, t_p=100\mu s$		I_{DM}	25	A
Avalanche energy			E_{AS}	18	mJ
Total Power Dissipation (Note 1,2)	Steady-State	$T_A=25^\circ C$	P_D	2.5	W
		$T_A=100^\circ C$		1.25	
Total Power Dissipation (Note 1,3)	Steady-State	$T_C=25^\circ C$		35	
		$T_C=100^\circ C$		17	
Junction and Storage Temperature Range			T_J, T_{STG}	-55~+175	$^\circ C$

■ Thermal resistance

Parameter		Symbol	Typ	Max	Units
Thermal Resistance Junction-to-Ambient (Note 2)	Steady-State	$R_{\theta JA}$	50	60	$^\circ C/W$
Thermal Resistance Junction-to-Case	Steady-State	$R_{\theta JC}$	3.5	4.2	

■ Ordering Information (Example)

PREFERRED P/N	PACKING CODE	Marking	MINIMUM PACKAGE(pcs)	INNER BOX QUANTITY(pcs)	OUTER CARTON QUANTITY(pcs)	DELIVERY MODE
YJQ120N10B	F1	Q120N10	5000	10000	100000	13" reel



YJQ120N10B

■ Electrical Characteristics (T_J=25°C unless otherwise noted)

Parameter	Symbol	Conditions	Min	Typ	Max	Units
Static Parameter						
Drain-Source Breakdown Voltage	BV _{DSS}	V _{GS} =0V, I _D =250μA	100	-	-	V
Zero Gate Voltage Drain Current	I _{DSS}	V _{DS} =100V, V _{GS} =0V	-	-	1	μA
		V _{DS} =100V, V _{GS} =0V, T _J =125°C	-	-	100	
Gate-Body Leakage Current	I _{GSS}	V _{GS} =±20V, V _{DS} =0V	-	-	±100	nA
Gate Threshold Voltage	V _{GS(th)}	V _{DS} =V _{GS} , I _D =250μA	1.3	1.8	2.3	V
Static Drain-Source On-Resistance	R _{DS(ON)}	V _{GS} =10V, I _D =8A	-	90	120	mΩ
		V _{GS} =4.5V, I _D =6A	-	92	130	
Diode Forward Voltage	V _{SD}	I _S =10A, V _{GS} =0V	-	-	1.2	V
Gate resistance	R _G	f=1MHz	-	3.5	-	Ω
Maximum Body-Diode Continuous Current	I _S		-	-	10	A
Dynamic Parameters						
Input Capacitance	C _{iss}	V _{DS} =50V, V _{GS} =0V, f=1MHz	-	998	-	pF
Output Capacitance	C _{oss}		-	28	-	
Reverse Transfer Capacitance	C _{rss}		-	22	-	
Switching Parameters						
Total Gate Charge	Q _g	V _{GS} =10V, V _{DS} =50V, I _D =10A	-	19	-	nC
Gate-Source Charge	Q _{gs}		-	3	-	
Gate-Drain Charge	Q _{gd}		-	3.6	-	
Reverse Recovery Charge	Q _{rr}	I _F =10A, di/dt=100A/us	-	25	-	nC
Reverse Recovery Time	t _{rr}		-	27	-	ns
Turn-on Delay Time	t _{D(on)}	V _{GS} =10V, V _{DD} =50V, I _D =10A R _{GEN} =2.2Ω	-	6.5	-	ns
Turn-on Rise Time	t _r		-	21	-	
Turn-off Delay Time	t _{D(off)}		-	21	-	
Turn-off fall Time	t _f		-	2.2	-	

Note:

- The entire application environment impacts the thermal resistance values shown, they are not constants and are only valid for the particular conditions noted.
- The value of R_{θJA} is measured with the device mounted on the 40mm*40mm*1.1mm single layer FR-4 PCB board with 1 in² pad of 2oz. Copper, in the still air environment with T_A=25°C. The maximum allowed junction temperature of 175°C. The value in any given application depends on the user's specific board design.
- Thermal resistance from junction to soldering point (on the exposed drain pad).



YJQ120N10B

Typical Electrical and Thermal Characteristics Diagrams

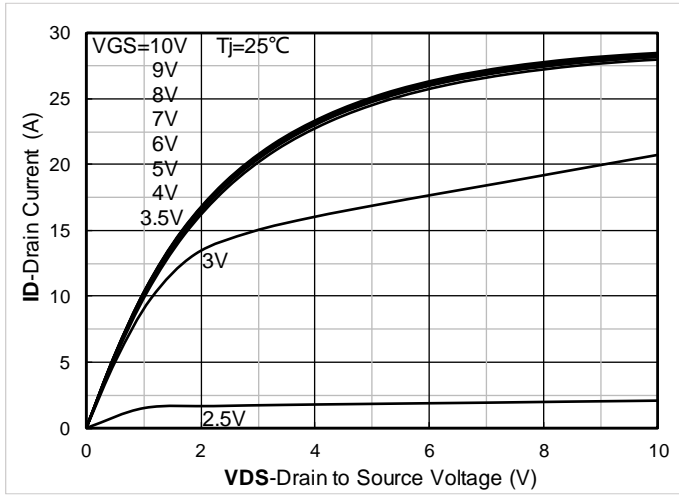

Figure 1. Output Characteristics

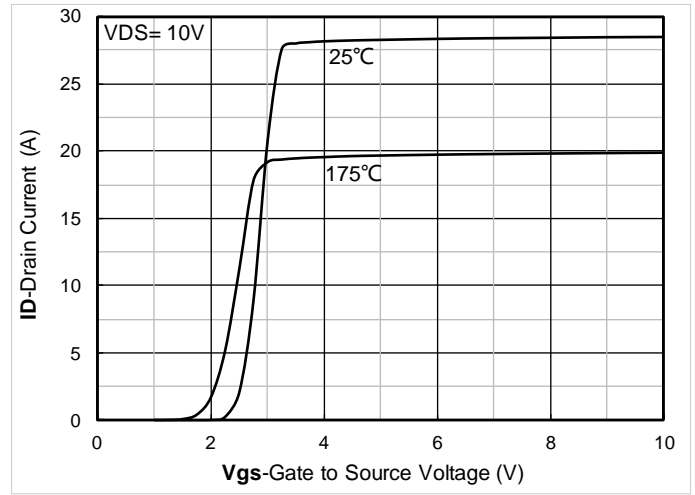

Figure 2. Transfer Characteristics

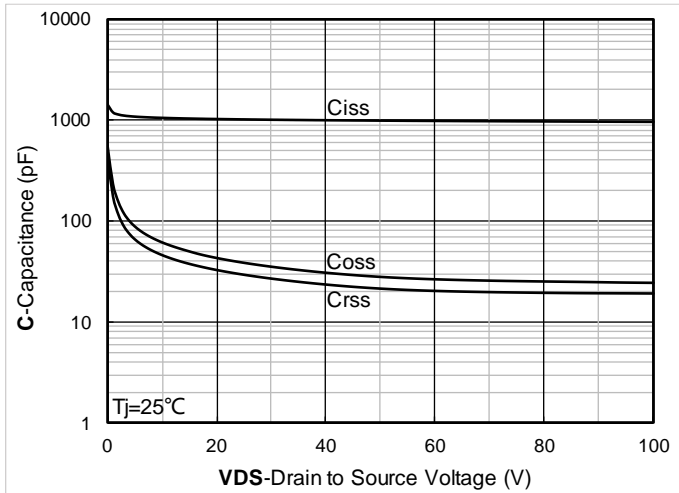

Figure 3. Capacitance Characteristics

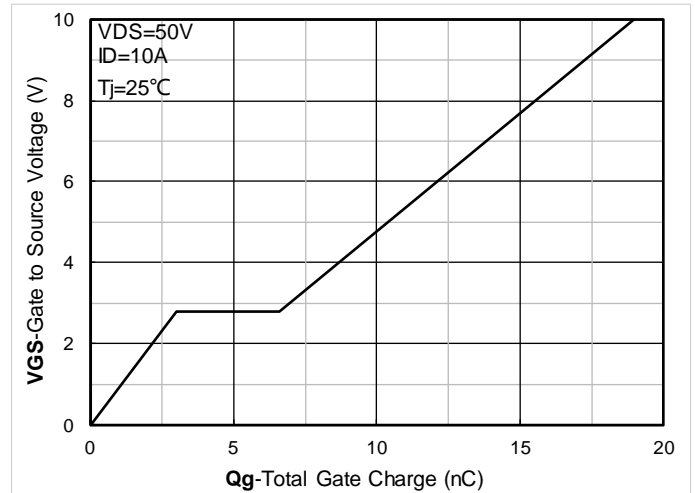

Figure 4. Gate Charge

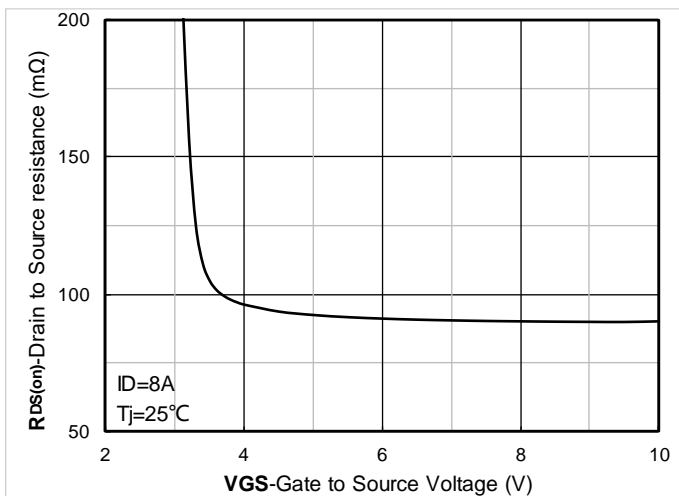

Figure 5. On-Resistance vs Gate to Source Voltage

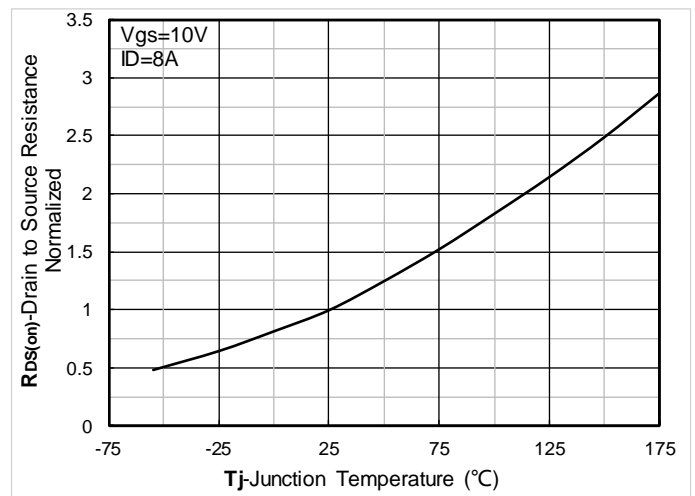

Figure 6. Normalized On-Resistance



YJQ120N10B

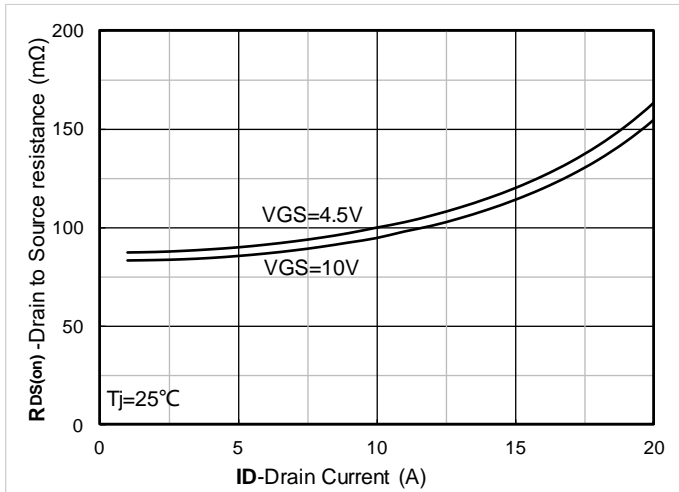

Figure 7. $R_{DS(on)}$ VS Drain Current

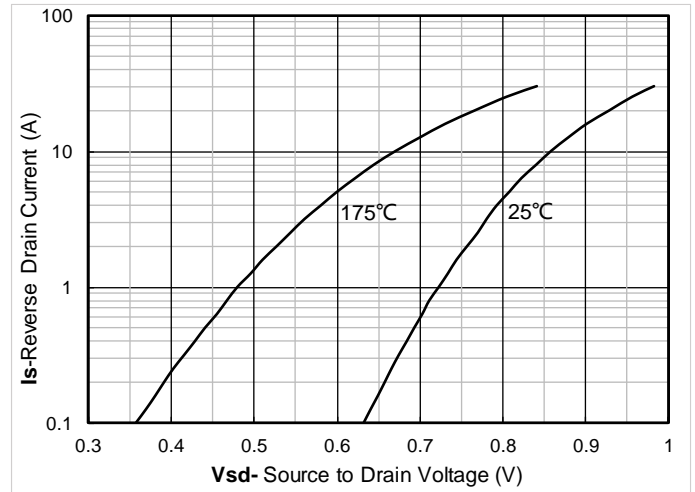

Figure 8. Forward characteristics of reverse diode

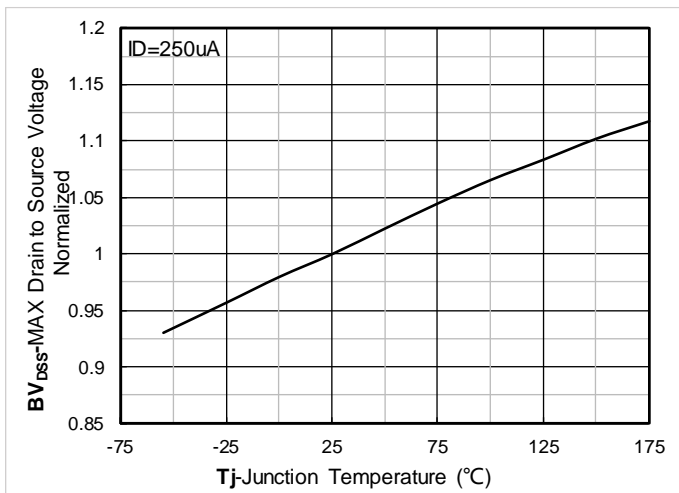

Figure 9. Normalized breakdown voltage

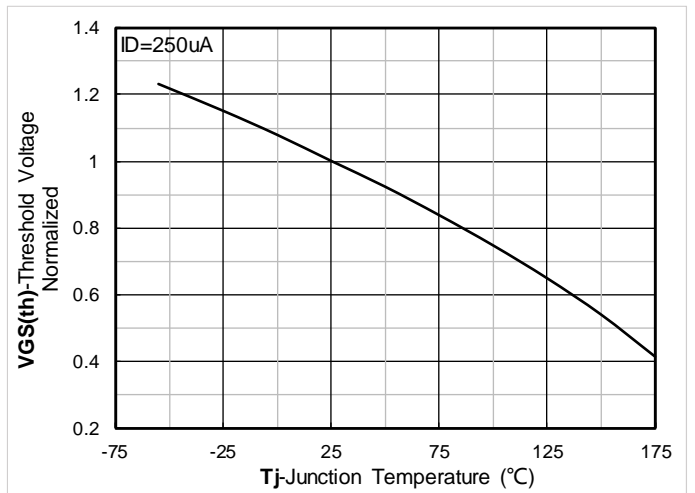

Figure 10. Normalized Threshold voltage

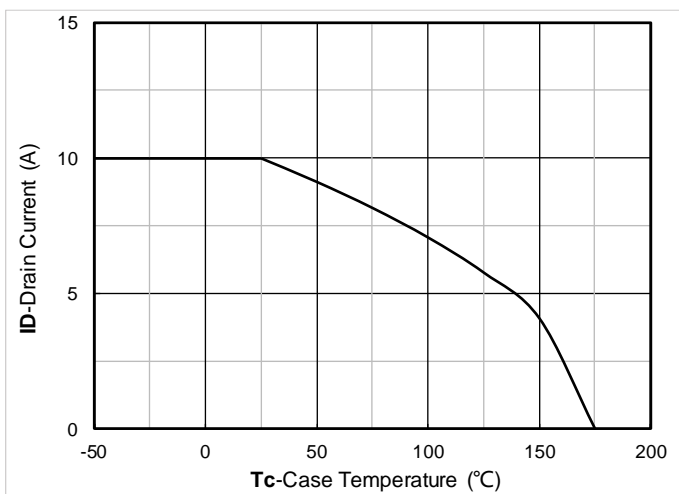

Figure 11. Current dissipation

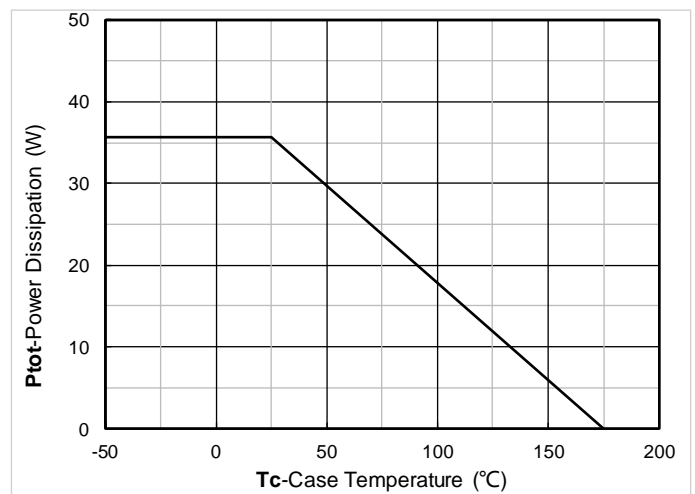

Figure 12. Power dissipation

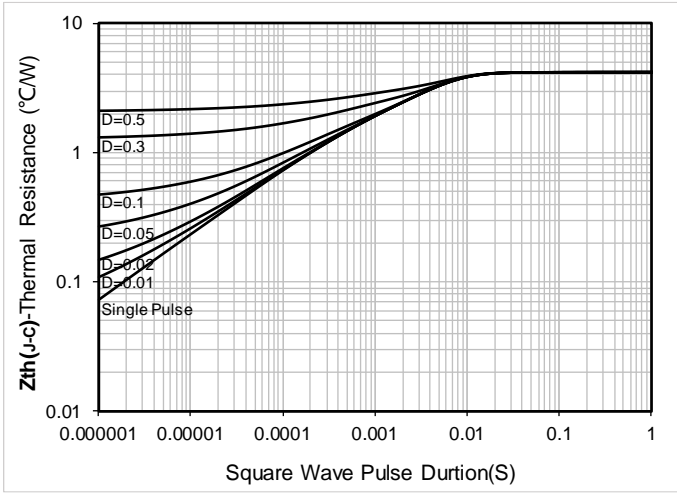

Figure 13. Maximum Transient Thermal Impedance

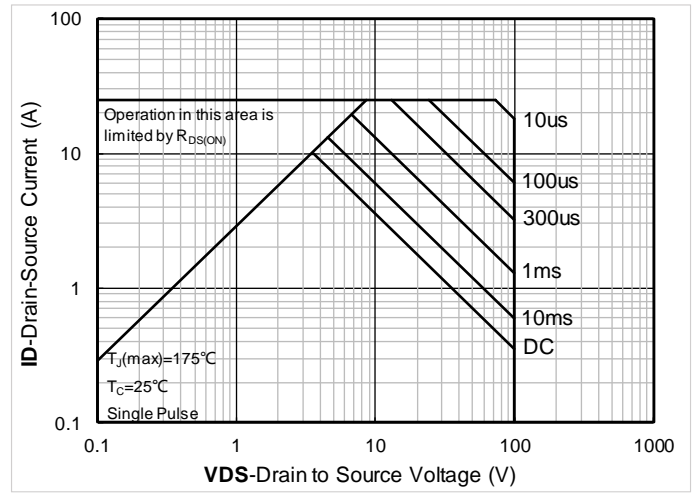

Figure 14. Safe Operation Area

■ Test Circuits & Waveforms

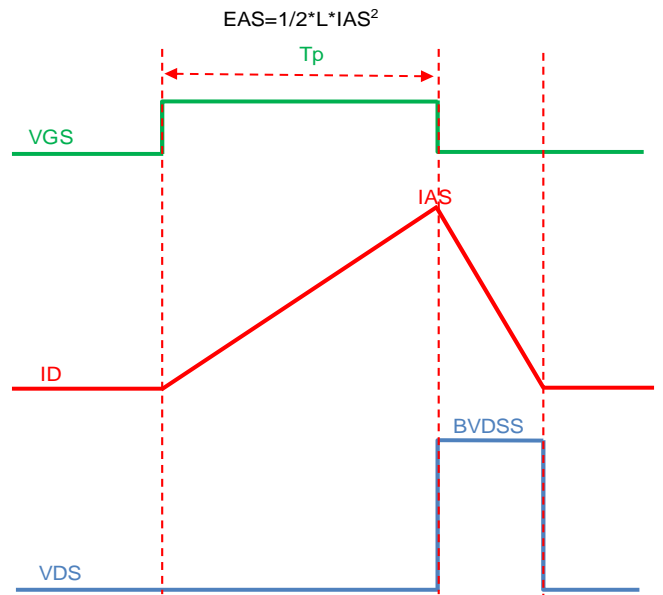
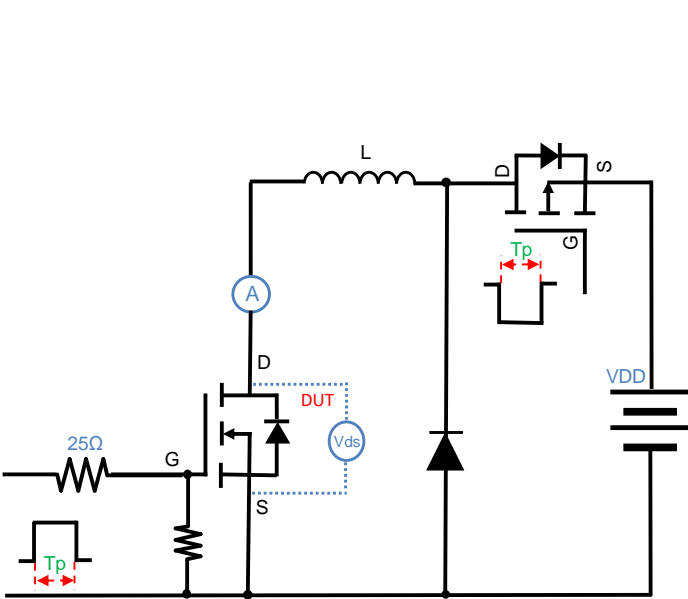

Figure A. Unclamped Inductive Switching (UIS) Test Circuit & Waveform

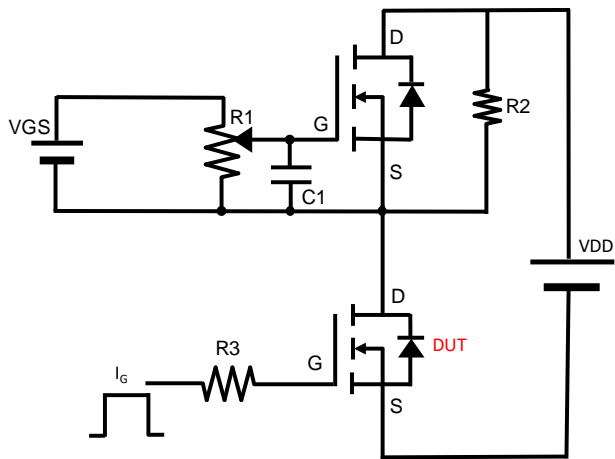

Figure B. Gate Charge Test Circuit & Waveform



Figure C. Resistive Switching Test Circuit & Waveform

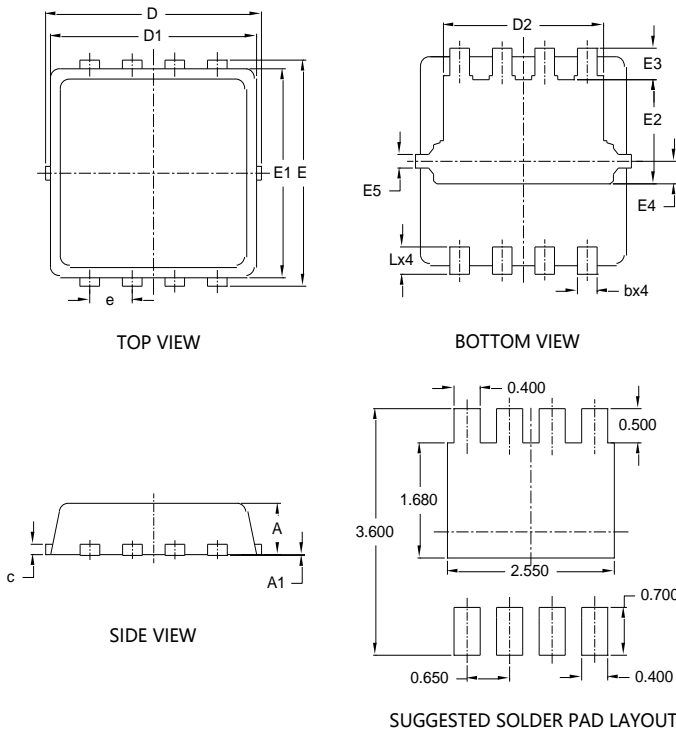

Figure D. Diode Recovery Test Circuit & Waveform



YJQ120N10B

■ PDFN3333-8L-B-0.75mm Package information



SYMBOL	DIMENSIONS			
	INCHES		Millimeter	
	MIN.	MAX.	MIN.	MAX.
A	0.028	0.033	0.700	0.850
A1	0.000	0.002	0.000	0.050
b	0.008	0.016	0.200	0.400
c	0.004	0.010	0.100	0.250
D	0.124	0.136	3.150	3.450
D1	0.118	0.130	3.000	3.300
D2	0.089	0.104	2.250	2.650
E	0.124	0.136	3.150	3.450
E1	0.114	0.126	2.900	3.200
E2	0.052	0.068	1.320	1.720
E3	0.011	0.026	0.280	0.650
E4	0.013 REF		0.330 REF	
E5	0.008 REF		0.200 REF	
e	0.026 BSC		0.650 BSC	
L	0.012	0.020	0.300	0.500

NOTE:
 1. PACKAGE BODY SIZES EXCLUDE MOLD FLASH AND GATE BURRS.
 2. TOLERANCE 0.1mm UNLESS OTHERWISE SPECIFIED.
 3. THE PAD LAYOUT IS FOR REFERENCE PURPOSES ONLY.

UNIT: mm



YJQ120N10B

Disclaimer

The information presented in this document is for reference only. Yangzhou Yangjie Electronic Technology Co., Ltd. reserves the right to make changes without notice for the specification of the products displayed herein to improve reliability, function or design or otherwise.

The product listed herein is designed to be used with ordinary electronic equipment or devices, and not designed to be used with equipment or devices which require high level of reliability and the malfunction of which would directly endanger human life (such as medical instruments, transportation equipment, aerospace machinery, nuclear-reactor controllers, fuel controllers and other safety devices), Yangjie or anyone on its behalf, assumes no responsibility or liability for any damages resulting from such improper use of sale.

This publication supersedes & replaces all information previously supplied. For additional information, please visit our website <http://www.21yangjie.com> , or consult your nearest Yangjie's sales office for further assistance.