

## P-Channel Enhancement Mode Field Effect Transistor

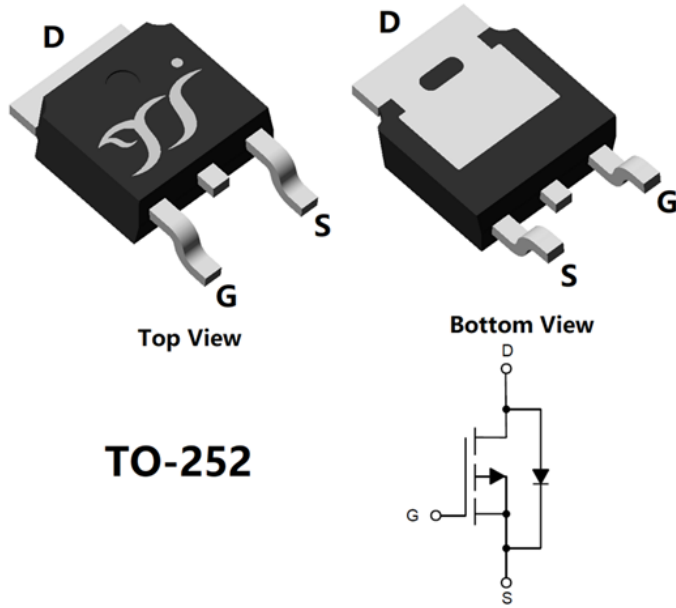

**TO-252**

### Product Summary

- $V_{DS}$  -40V
- $I_D$  -47A
- $R_{DS(ON)}$ ( at  $V_{GS}=-10V$ ) < 12m $\Omega$
- $R_{DS(ON)}$ ( at  $V_{GS}=-4.5V$ ) < 22m $\Omega$
- 100% EAS Tested
- 100%  $\nabla V_{DS}$  Tested

### General Description

- Low  $R_{DS(on)}$  & FOM
- Extremely low switching loss
- Excellent stability and uniformity
- Moisture Sensitivity Level 1
- Epoxy Meets UL 94 V-0 Flammability Rating
- Halogen Free

### Applications

- Power management
- Portable equipment

### Limiting Values

Parameter	Conditions		Symbol	Min	Max	Unit
Drain-source Voltage			$V_{DS}$	-	-40	V
Gate-source Voltage			$V_{GS}$	-20	20	
Continuous Drain Current (Note 1,2)	Steady-State	$T_A=25^{\circ}C, V_{GS}=-10V$	$I_D$	-	-11	A
		$T_A=100^{\circ}C, V_{GS}=-10V$		-	-7	
Continuous Drain Current (Note 1,3)	Steady-State	$T_C=25^{\circ}C, V_{GS}=-10V, \text{Chip limitation}$		-	-47	
		$T_C=100^{\circ}C, V_{GS}=-10V$		-	-29	
Pulsed Drain Current	$T_C=25^{\circ}C, t_p \leq 10\mu s$		$I_{DM}$	-	-188	
Maximum Body-Diode Continuous Current	$T_C=25^{\circ}C$		$I_S$		-40	
Avalanche energy (non-repetitive )	$T_J=25^{\circ}C, V_G=-10V, R_G=25\Omega, L=0.5mH, I_{AS}=-18.9A$		EAS	-	89.3	mJ
Total Power Dissipation (Note 1,2)	Steady-State	$T_A=25^{\circ}C$	$P_D$	-	2.5	W
		$T_A=100^{\circ}C$		-	1	
Total Power Dissipation (Note 1,3)	Steady-State	$T_C=25^{\circ}C$		-	44	
		$T_C=100^{\circ}C$		-	17	
Junction and Storage Temperature Range			$T_J, T_{STG}$	-55	150	$^{\circ}C$

### Thermal Resistance

Parameter		Symbol	Typ	Max	Units
Thermal Resistance Junction-to-Ambient (Note 2)	Steady-State	$R_{\theta JA}$	-	50	$^{\circ}C/W$
Thermal Resistance Junction-to-Case	Steady-State	$R_{\theta JC}$	-	2.8	

### Ordering Information (Example)

PREFERRED P/N	PACKING CODE	Marking	MINIMUM PACKAGE(pcs)	INNER BOX QUANTITY(pcs)	OUTER CARTON QUANTITY(pcs)	DELIVERY MODE
YJD012P04A	F1/F2	YJD012P04A	2500	/	25000	13" reel



# YJD012P04A

## ■ Electrical Characteristics

s	Symbol	Conditions	Min	Typ	Max	Units
<b>Static Parameter</b>						
Drain-Source Breakdown Voltage	$BV_{DSS}$	$V_{GS}=0V, I_D=-250\mu A, T_J=25^\circ C$	-40	-	-	V
Zero Gate Voltage Drain Current	$I_{DSS}$	$V_{DS}=-40V, V_{GS}=0V, T_J=25^\circ C$	-	-	-1	$\mu A$
		$V_{DS}=-40V, V_{GS}=0V, T_J=150^\circ C$	-	-	-100	
Gate-Source Leakage Current	$I_{GSS}$	$V_{GS}=\pm 20V, V_{DS}=0V, T_J=25^\circ C$	-	-	$\pm 100$	nA
Gate Threshold Voltage	$V_{GS(th)}$	$V_{DS}=V_{GS}, I_D=-250\mu A, T_J=25^\circ C$	-1.2	-1.7	-2.2	V
Static Drain-Source On-Resistance	$R_{DS(on)}$	$V_{GS}=-10V, I_D=-20A, T_J=25^\circ C$	-	9.5	12	$m\Omega$
		$V_{GS}=-4.5V, I_D=-20A, T_J=25^\circ C$	-	16.5	22	$m\Omega$
Diode Forward Voltage	$V_{SD}$	$I_S=-20A, V_{GS}=0V, T_J=25^\circ C$	-	-0.88	-1.2	V
Gate Resistance	$R_G$	$f=1MHz, T_J=25^\circ C$	-	5.9	-	$\Omega$
<b>Dynamic Parameters</b>						
Input Capacitance	$C_{iss}$	$V_{DS}=-20V, V_{GS}=0V, f=1MHz, T_J=25^\circ C$	-	2595	-	$pF$
Output Capacitance	$C_{oss}$		-	265	-	
Reverse Transfer Capacitance	$C_{rss}$		-	240	-	
<b>Switching Parameters</b>						
Total Gate Charge	$Q_g$	$V_{GS}=-10V, V_{DS}=-20V, I_D=-20A, T_J=25^\circ C$	-	55.6	-	nC
Gate-Source Charge	$Q_{gs}$		-	10.5	-	
Gate-Drain Charge	$Q_{gd}$		-	8.6	-	
Reverse Recovery Charge	$Q_{rr}$	$I_F=-20A, di/dt=100A/\mu s, V_{GS}=0V, V_R=-20V, T_J=25^\circ C$	-	21.3	-	nC
Reverse Recovery Time	$t_{rr}$		-	24	-	ns
Turn-on Delay Time	$t_{D(on)}$	$V_{GS}=-10V, V_{DS}=-20V, I_D=-20A, R_{GEN}=3\Omega, T_J=25^\circ C$	-	10	-	ns
Turn-on Rise Time	$t_r$		-	13	-	
Turn-off Delay Time	$t_{D(off)}$		-	72	-	
Turn-off Fall Time	$t_f$		-	43	-	

### Note:

- The entire application environment impacts the thermal resistance values shown, they are not constants and are only valid for the particular conditions noted.
- The value of  $R_{\theta JA}$  is measured with the device mounted on the 40mm\*40mm\*1.1mm single layer FR-4 PCB board with 1 in<sup>2</sup> pad of 2oz. Copper, in the still air environment with  $T_A=25^\circ C$ . The maximum allowed junction temperature of  $150^\circ C$ . The value in any given application depends on the user's specific board design.
- Thermal resistance from junction to soldering point (on the exposed drain pad).



## Typical Electrical and Thermal Characteristics Diagrams

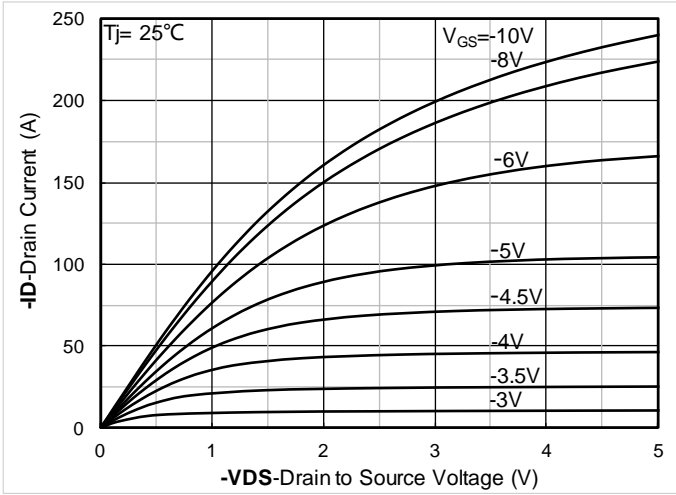

Figure 1. Output Characteristics; typical values

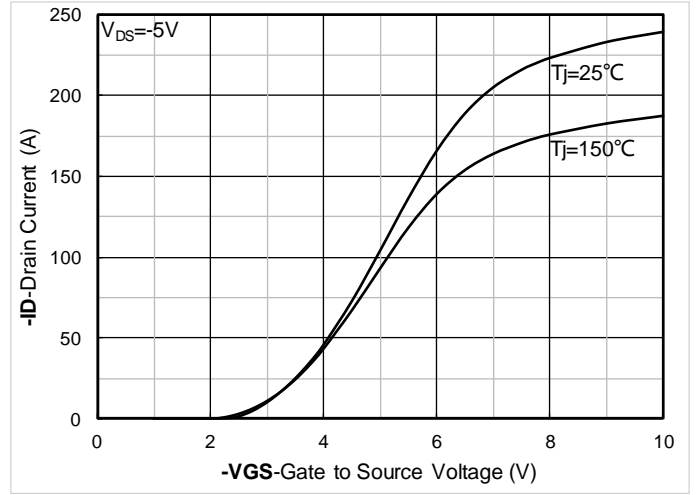

Figure 2. Transfer Characteristics; typical values

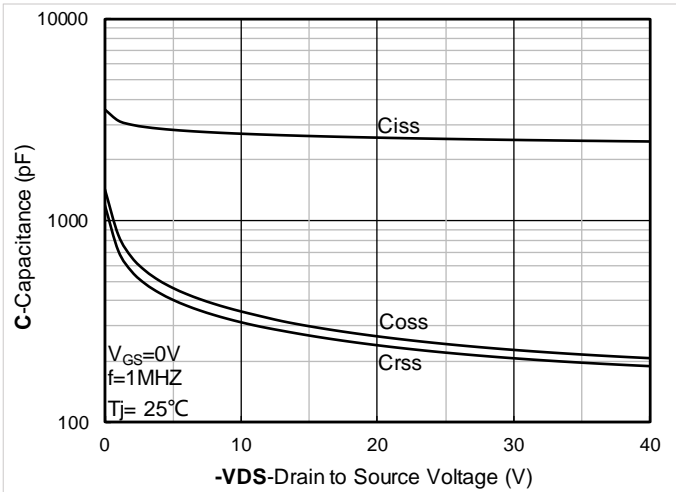

Figure 3. Capacitance Characteristics; typical values

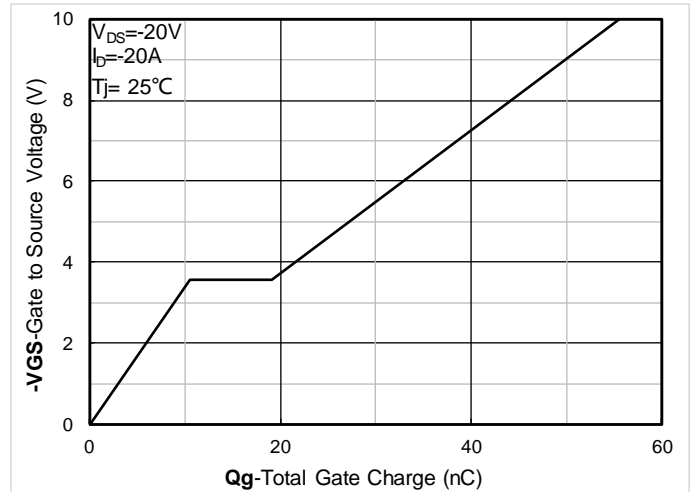

Figure 4. Gate Charge; typical values

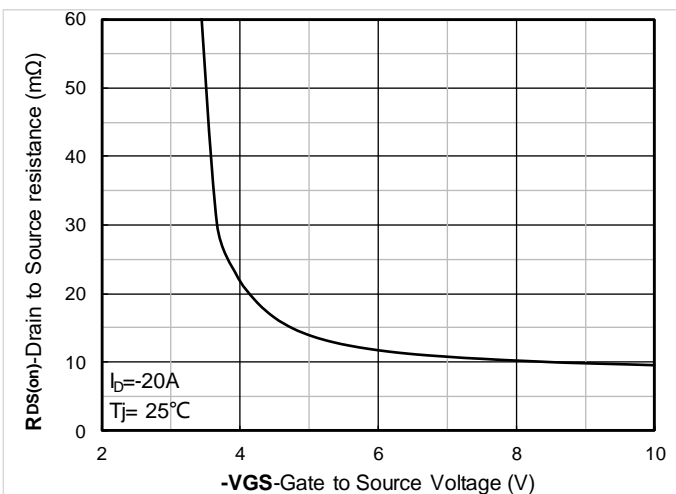

Figure 5. On-Resistance vs. Gate to Source Voltage; typical values

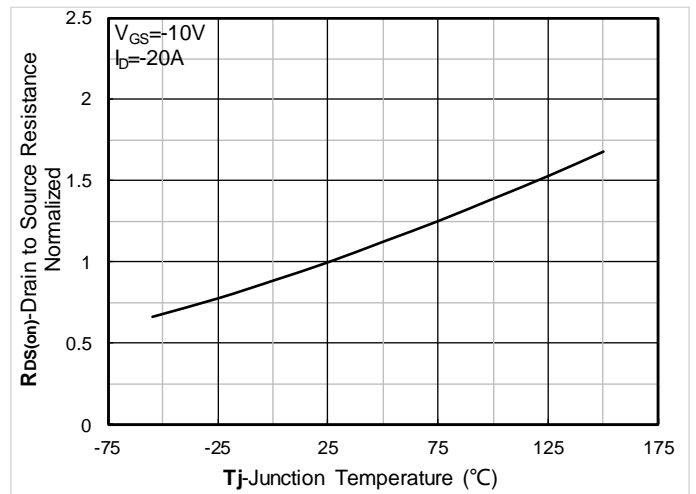

Figure 6. Normalized On-Resistance



# YJD012P04A

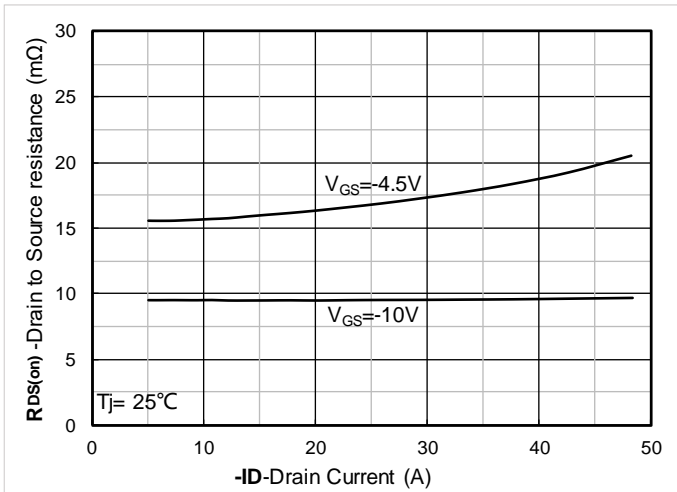

Figure 7. RDS(on) vs. Drain Current; typical values

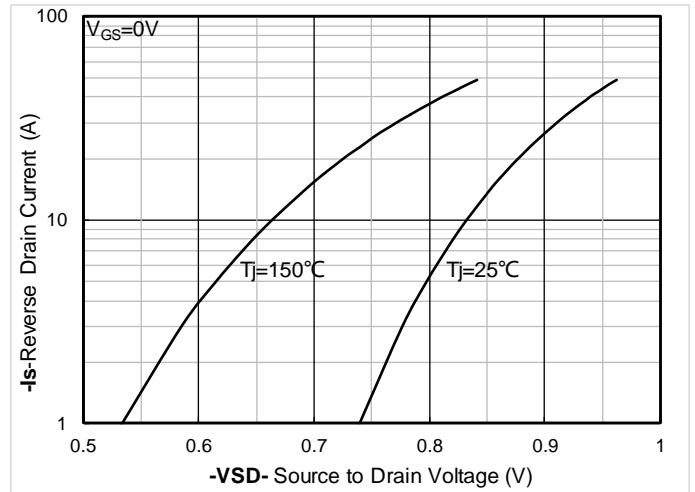

Figure 8. Forward characteristics of reverse diode; typical values

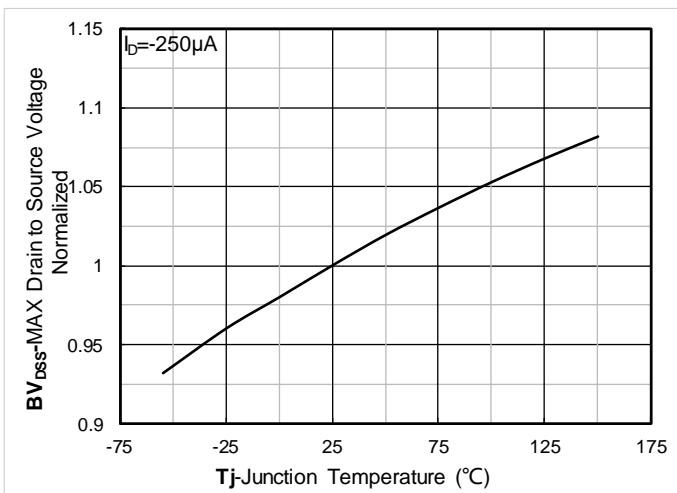

Figure 9. Normalized breakdown voltage

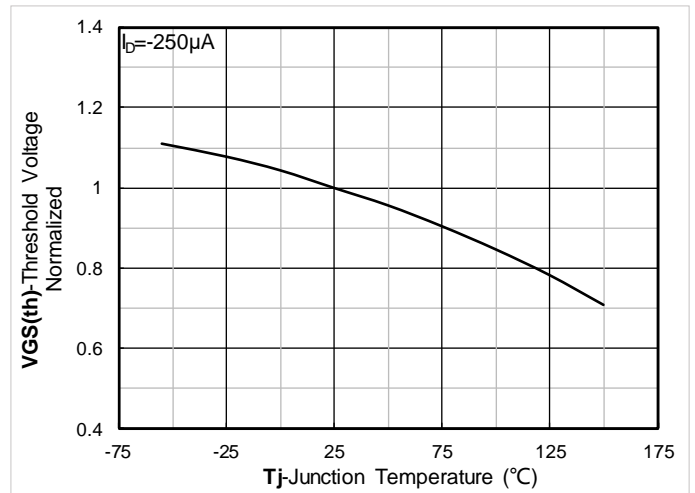

Figure 10. Normalized Threshold voltage

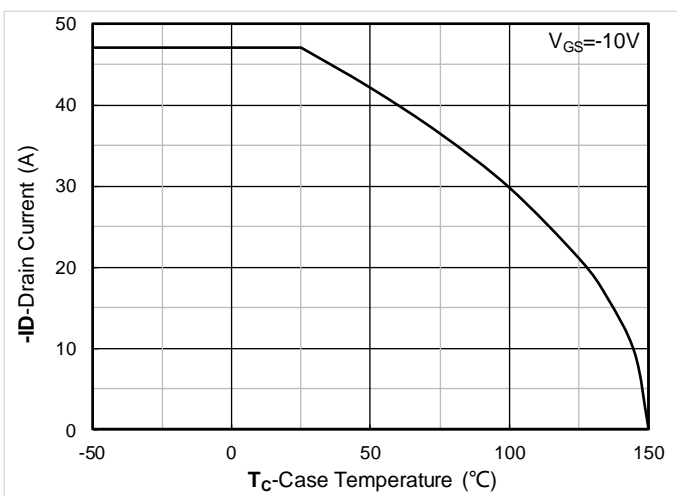

Figure 11. Current dissipation

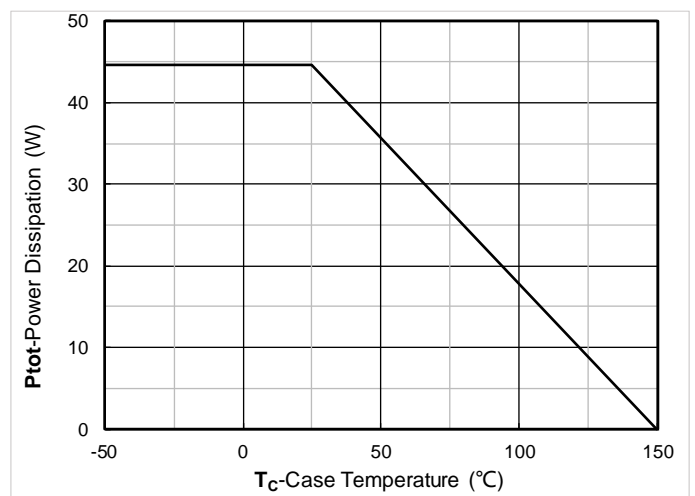

Figure 12. Power dissipation



# YJD012P04A

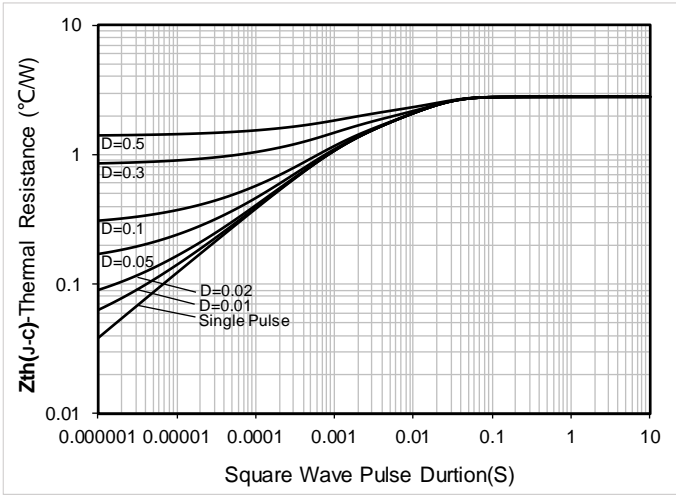

Figure 13. Maximum Transient Thermal Impedance

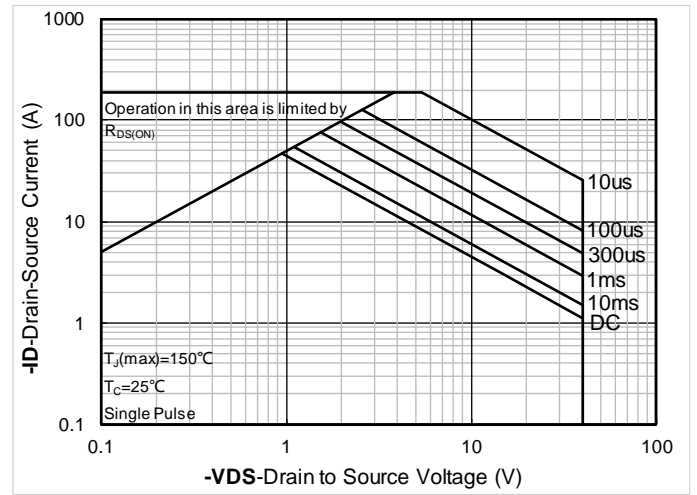
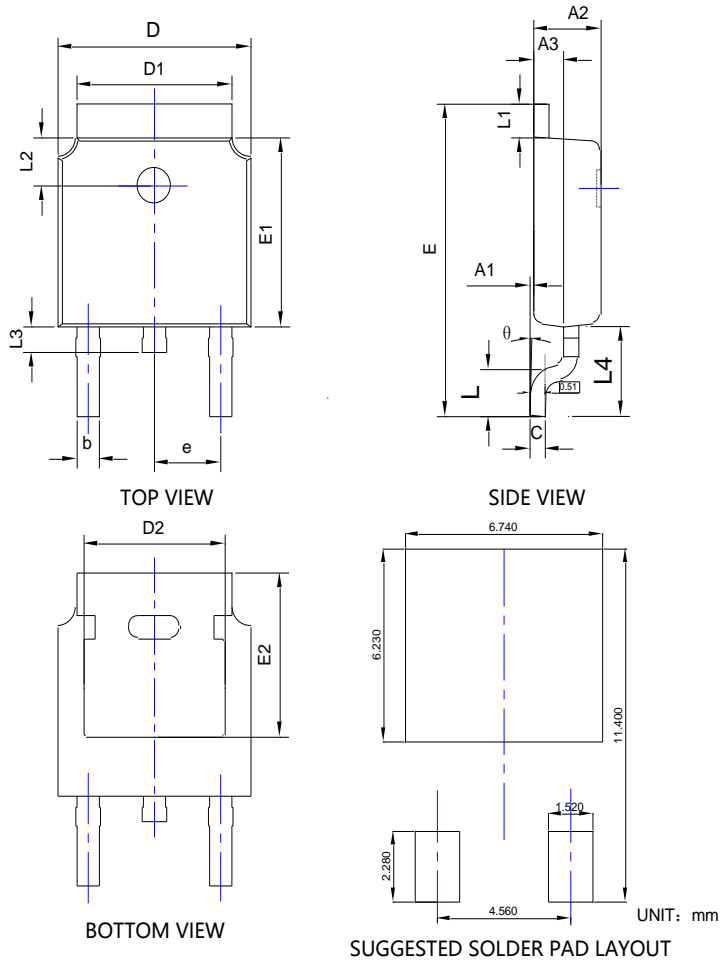

Figure 14. Safe Operation Area



# YJD012P04A

## ■ TO-252-B Package Information



SYMBOL	DIMENSIONS					
	INCHES			Millimeter		
	MIN.	NOM.	MAX.	MIN.	NOM.	MAX.
A1	0.000	---	0.008	0.000	---	0.200
A2	0.087	0.091	0.094	2.200	2.300	2.400
A3	0.035	0.039	0.043	0.900	1.000	1.100
b	0.026	0.030	0.034	0.660	0.760	0.860
c	0.018	0.020	0.023	0.460	0.520	0.580
D	0.256	0.260	0.264	6.500	6.600	6.700
D1	0.203	0.209	0.215	5.150	5.300	5.450
D2	0.181	0.189	0.195	4.600	4.800	4.950
E	0.390	0.398	0.406	9.900	10.100	10.300
E1	0.236	0.240	0.244	6.000	6.100	6.200
E2	0.203	0.209	0.215	5.150	5.300	5.450
e	0.090BSC			2.286BSC		
L	0.049	0.059	0.069	1.250	1.500	1.750
L1	0.035	---	0.050	0.900	---	1.270
L2	0.055	---	0.075	1.400	---	1.900
L3	0.024	0.031	0.039	0.600	0.800	1.000
L4	0.114REF			2.900REF		
$\theta$	0°	---	10°	0°	---	10°

NOTE:  
 1. PACKAGE BODY SIZES EXCLUDE MOLD FLASH AND GATE BURRS.  
 2. TOLERANCE 0.1mm UNLESS OTHERWISE SPECIFIED.  
 3. THE PAD LAYOUT IS FOR REFERENCE PURPOSES ONLY.

## ■ Marking Information

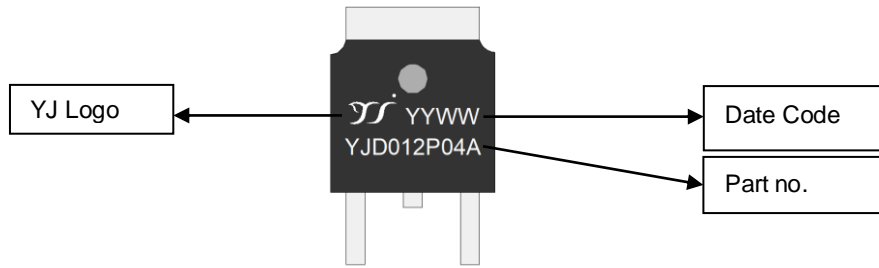

**Note:**

1. All marking is at middle of the product body
2. All marking is in laser printing
3. YJD012P04A is part no., YYWW is date code, "YY" is year, "WW" is week
4. Body color: Black



## YJD012P04A

---

### Disclaimer

The information presented in this document is for reference only. Yangzhou Yangjie Electronic Technology Co., Ltd. reserves the right to make changes without notice for the specification of the products displayed herein to improve reliability, function or design or otherwise.

The product listed herein is designed to be used with ordinary electronic equipment or devices, and not designed to be used with equipment or devices which require high level of reliability and the malfunction of which would directly endanger human life (such as medical instruments, transportation equipment, aerospace machinery, nuclear-reactor controllers, fuel controllers and other safety devices), Yangjie or anyone on its behalf, assumes no responsibility or liability for any damages resulting from such improper use of sale.

This publication supersedes & replaces all information previously supplied. For additional information, please visit our website <http://www.21yangjie.com> , or consult your nearest Yangjie's sales office for further assistance.